

# MARVEL SUPER HEROES™

OFFICIAL GAME ACCESSORY

## WEAPONS LOCKER

By Jerry Epperson and Jeff Grubb



TSR, Inc.  
PRODUCTS OF YOUR IMAGINATION™

All Marvel characters and the distinctive likenesses thereof are trademarks of the Marvel Comics Group. MARVEL SUPER HEROES and MARVEL SUPER VILLAINS are trademarks of the Marvel Comics Group. Copyright ©1985 Marvel Comics Group, a division of Cadence Industries Corporation. All Rights Reserved. Printed in U.S.A.

The names of characters used herein are fictitious and do not refer to any person living or dead. Any descriptions including similarities to persons living or dead are merely coincidental. DUNGEONS & DRAGONS, PRODUCTS OF YOUR IMAGINATION, and the TSR logo are trademarks owned by TSR, Inc.

Game Design ©1985 TSR, Inc. All Rights Reserved

# IRON MAN'S™ ARMOR

DESIGN BY ANTHONY STARK BUILT BY STARK INTERNATIONAL

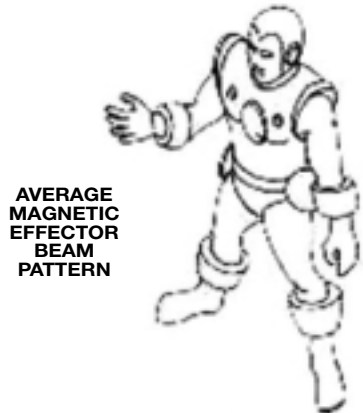

AVERAGE MAGNETIC EFFECTOR BEAM PATTERN



UPPER SURFACE HIGH EFFICIENCY ACTIVATED CESIUM SOLAR ENERGY COLLECTORS

MAJOR SUIT MOVEMENT ROUTINE COMPUTER ASSEMBLY

OXYGEN SUPPLY

POWER PODS (STORE LARGE AMOUNTS OF ENERGY)

MICRO-SCALE SUIT TILES FABRICATED BY GENETICALLY ENGINEERED METAL AFFINITY BACTERIA WHICH ASSEMBLE THEMSELVES IN SPECIFIC ORDERLY ARRAYS, THEN EXPIRE, LEAVING BEHIND VARIOUS METALLIC DEPOSITS WHICH FORM ALL THE METAL SHAPES AND MICRO-ELECTRONIC CIRCUITS

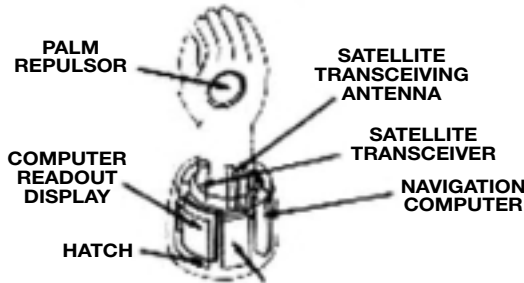

PALM REPULSOR

SATELLITE TRANSCIVING ANTENNA

COMPUTER READOUT DISPLAY

SATELLITE TRANSCIVER

NAVIGATION COMPUTER

HATCH

PLASMA GENERATORS

REPULSOR PLASMA GENERATOR TIMING COMPUTER AND POWER CIRCUITRY

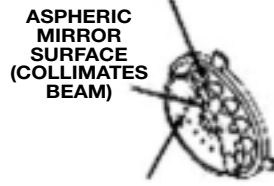

ASPHERIC MIRROR SURFACE (COLLIMATES BEAM)



MINI-ION GENERATORS

MAGNETIC FOCUS RING

FUEL CONDENSER PUMP

TURBINE AIR INLET AND FILTRATION

PLASMA BEAM ORIFICES

LIQUID OXYGEN FUEL TANKS

LIQUID OXYGEN DISTILLATION CONDENSER

THREE AXIS YIN-YANG STEERING MAGNET ARRAY

FIRE SUPPRESSION SYSTEM

JET EXHAUST DUCTING

FINAL BEAM EXIT COLLIMATER YIN-YANG MAGNET ARRAY

ELECTRONIC COOLING FOOT PAD

TREAD SURROUNDING JET EXHAUST

INTERNAL FOOT BRACING

TESSLATION PATTERN (FROM AREA OF RIBS)



AVERAGE SINGLE TILE



AVERAGE TILE CROSS SECTION ENLARGEMENT

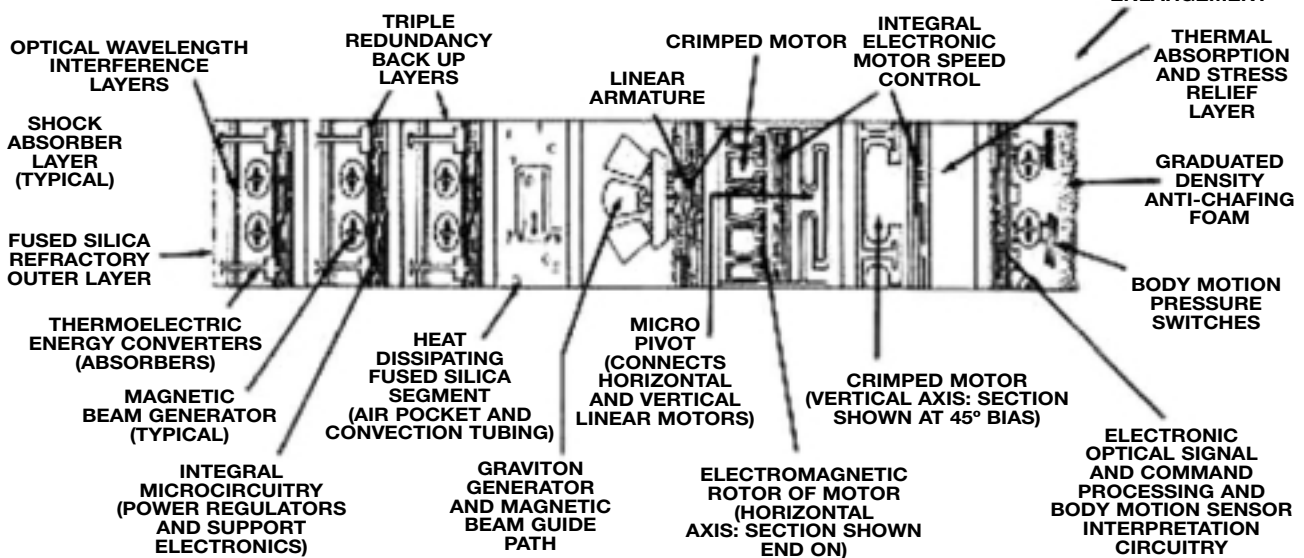

OPTICAL WAVELENGTH INTERFERENCE LAYERS

TRIPLE REDUNDANCY BACK UP LAYERS

CRIMPED MOTOR

INTEGRAL ELECTRONIC MOTOR SPEED CONTROL

THERMAL ABSORPTION AND STRESS RELIEF LAYER

SHOCK ABSORBER LAYER (TYPICAL)

LINEAR ARMATURE

GRADUATED DENSITY ANTI-CHAFING FOAM

FUSED SILICA REFRACTORY OUTER LAYER

THERMOELECTRIC ENERGY CONVERTERS (ABSORBERS)

HEAT DISSIPATING FUSED SILICA SEGMENT (AIR POCKET AND CONVECTION TUBING)

MICRO PIVOT (CONNECTS HORIZONTAL AND VERTICAL LINEAR MOTORS)

CRIMPED MOTOR (VERTICAL AXIS: SECTION SHOWN AT 45° BIAS)

BODY MOTION PRESSURE SWITCHES

MAGNETIC BEAM GENERATOR (TYPICAL)

INTEGRAL MICROCIRCUITRY (POWER REGULATORS AND SUPPORT ELECTRONICS)

GRAVITON GENERATOR AND MAGNETIC BEAM GUIDE PATH

ELECTROMAGNETIC ROTOR OF MOTOR (HORIZONTAL AXIS: SECTION SHOWN END ON)

ELECTRONIC OPTICAL SIGNAL AND COMMAND PROCESSING AND BODY MOTION SENSOR INTERPRETATION CIRCUITRY

# WEAPONS LOCKER

By Jerry Epperson and Jeff Grubb

Welcome to the Weapons Locker, a copious compendium of crafted creations sure to contribute to any campaign!

This book lists weapons and weapon systems, including, but not limited to battlesuits, ray-guns, unique and personal weapons, and all manner of destructive devices ranging from handguns to missiles payloads.

This book is divided into two primary sections BATTLESUITS and WEAPONS. The Battlesuits section lists armored combat suits in complete detail The Weapons section concerns itself with both common and uncommon instruments of destruction, including a wide variety of "standard" weapons for use by "normal" agents of subversive agencies.

Battlesuits have the following notation Name; Availability and Price (if applicable); Builder; Inventor; and Wearer; Ability Modifiers; Known Powers and Design Notes.

The Name of the armor is its make and type, usually the code name of the wearer, but often, as the case with MANDROID™ and SECBOT™ armor, a separate entity in itself.

Availability and Price refers to how easy it is to obtain the various suits. Most suits are unique creations, but some may be available on the black market.

Builder and Inventor indicates who designed and built the suit. The Wearer indicates who is wearing (or was wearing at last report) the armor, as well as a summary of that character's ability scores, so the judge may use the character and the armor.

Ability Modifiers show how the suit alters the Fighting, Agility, Strength or Endurance of a character. An ability may be raised by a number of ranks to a listed maximum rank. If a more powerful character puts on a suit that allows a maximum of a lower rank, that character's abilities are at that lower rank.

Known Powers are all the capabilities of the suit that are known to date, both exhibited or listed in the *OFFICIAL HANDBOOK OF THE MARVEL UNIVERSE*™.

Design Notes is a brief history of the suit, those who wore it, and its relative success in combat. The present fate of the suit is listed where known.

The Weapons section is divided into two

subsections: Common weapons and Unique weapons. Common weapons are those potentially available to the bad guys and population at large, while Unique weapons are single modified items with unique power.

Common weapons are broken down by Name; Price; Range (in areas) Normal Damage (using standard ammunition); Rate of Fire; and Number of Shots that may be fired before reloading is required. Design Notes mention any special characteristic of the weapon.

There are usually two entries for Price. The first entry is for an open market, while the second is a black market price (for bad guys) or government price (for good guys). The Black Market is the criminal underground moving these weapons, and while untraceable, there is a 1 in 10 chance that a black market item malfunctions. Government cost reflects the amount of additional paperwork involved, and the government keeps very close tabs on any weapon given to a hero.

Unique weapons are modified and special items used by particular heroes and villains. Their listing includes Name; Designer/Builder/User, Known Powers; and Design Notes in a similar manner to Battlesuits.

Often poison, knock-out gases, stun-rays, and blinding lights are listed as having a certain rank of potency or intensity. This rank affects the type of FEAT roll (usually Endurance) needed to avoid the effects of the poison or knock-out gas. If the ability is higher than the potency of gas or poison, the player must make a green FEAT roll to avoid its effects. If the two are equal, a yellow FEAT roll must be made. If the ability is lower than the potency, a red FEAT roll must be made. For example, an Amazing potency gas causes a character with Good Endurance to make a red FEAT roll, one with an Amazing Endurance to a yellow FEAT roll, and one with Monstrous Endurance a green FEAT roll.

A final note on the makers of the weapons of war: We use many names under the building section, so here is a brief tour of the Marvel Universe's weaponsmiths:

STARK INTERNATIONAL™ began as STARK INDUSTRIES™, founded by TONY STARK™'s father, Howard. It ceased weapon production several years back,

but became STANE INTERNATIONAL™ recently.

STANE INTERNATIONAL was owned and operated by OBADIAH STANE™, having driven Stark out of business Stane killed himself following a battle with IRON MAN™. The present disposition of the corporation is in the courts.

CORD CONGLOMERATES™, better known as CORDCO™, engaged in high-tech scientific and government contract work. It declared bankruptcy following scandals involving the MAULER™ and RAIDER™ armors, and was purchased by Stark International.

ROXXON OIL™ is the world's largest multinational industry, and is not above engaging in criminal activity to achieve its goals. Its subsidiary, the BRAND CORPORATION™, provided a whole host of super-powered agents before being closed down.

JUSTIN HAMMER™ is the brains behind a series of holding companies whose net worth rivals that of Stark International itself Hammer uses his money to refit and refurbish villains' equipment in return for a percentage of their profits. Iron Man has fought Hammer twice, and Hammer's present location is unknown.

S.H.I.E.L.D.™ stands for Supreme Headquarters International Espionage and Law-enforcement Division, a para-military operation dedicated to the security of the free world.

THE CORPORATION™ was a band of corrupt Californian businessmen They have since been disbanded.

THE COMMITTEE™ was a similar band of criminals who worked with SENATOR EUGENE KLIGGER STIVAK™ toward world domination. They were a front for an alien invasion and have been disbanded as well.

AIM™ stands for Advanced Idea Mechanics, a branch of the subversive organization HYDRA that became independent Their chief achievements have been the SUPER-ADAPTOID™ and COSMIC CUBE™, but deal with a number of energy weapons as well Until recently, they have been under the control of MODOK™.

With all that said, on to the weapons!

**Designers: Jerry Epperson and Jeff Grubb**  
**Editor: Anna Gray McCready**  
**Cover: Mark Bright (Color: Jeff Butler)**  
**Illustrations: the Mighty Bullpen**  
**Graphic Design: Dennis Kauth**  
**Typeset by: Betty Elmore**

**TSR Inc.**  
**POB 756, Lake Geneva, WI 53147**  
**ISBN 394-54874-4TSR0600**  
**0-88038-229-5**  
**6868XXX1501**

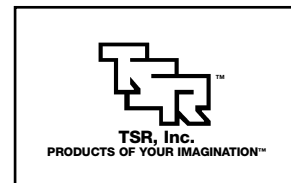

The names and characters used herein are fictitious and do not refer to any persons living or dead. Any descriptions, including similarities to persons living or dead are merely coincidental. All Marvel Characters, names, and the distinctive likenesses thereof are trademarks of the Marvel Comics Group. MARVEL SUPER HEROES is a trademark of the Marvel Comics Group, Copyright ©1985 Marvel Comics Group, a division of Cadence Industries Corporation. All rights reserved. Printed in the U.S.A. PRODUCTS OF YOUR IMAGINATION and the TSR logo are trademarks owned by TSR, Inc. Game Design copyright ©1985 TSR Inc. All Rights Reserved.

This book is protected under the copyright laws of the United States of America. Any reproduction or other unauthorized use of the material or artwork contained herein is prohibited without the express written consent of TSR Inc. and Marvel Comics Group. Distributed to the book trade in the United States by Random House, Inc. and in Canada by Random House of Canada, Ltd. Distributed to the toy and hobby trade by regional distributors.

# BATTLESUITS



## IRON MAN™ ARMOR

Original Grey Armor

**Availability:** Unique, believed destroyed

**Constructed by:** Tony Stark/Ho Yinsen

**Inventor:** Tony Stark/Ho Yinsen

**Worn By:** Tony Stark (see Iron Man Armor, Golden Avenger Armor)

### ABILITY MODIFIERS

Raises Fighting by 1 rank

(Maximum of GOOD)

Lowers Agility by 1 rank

(Minimum of POOR)

Raises Strength by 3 ranks

(Maximum of REMARKABLE)

Raises Endurance by 3 ranks

(Maximum of INCREDIBLE)

### KNOWN POWERS

#### BODY ARMOR

- The original Iron Man armor was an electrically-powered, transistorized suit of armor, made of Remarkable material.
- The armor provides Remarkable protection against physical damage.
- The armor provides Typical protection against heat, cold, energy, and acid attacks.

#### ENERGY ABSORPTION

- The armor is powered by electrical energy, and can absorb up to a Monstrous amount of energy at anytime. This energy is then expended through normal use.

#### REVERSE MAGNETISM

- A reverse magnetic device built into one arm allows the wearer Remarkable control over magnetism.

### LIFE SUPPORT

- The suit cannot function long underwater or in a vacuum.
- The suit chest-plate contains an external pacemaker that helped keep Stark's heart beating when he was wounded.

### DESIGN NOTES

Iron Man was "born" in South East Asia, where industrialist Tony Stark was wounded by a piece of shrapnel and taken prisoner by communist insurgents. The leader of these communists, Wong-Chu, permitted Stark to build his insurgents a weapon in return for removing the shrapnel and saving Stark's life. Stark and a captive physicist, Ho Yinsen, worked on the armor in a small laboratory, intent on producing a weapon that would free them both and save Stark's life. Yinsen died delaying Wong-Chu while Tony powered the armor, but as Iron Man Stark avenged his fellow prisoner's death.

Scattering the guerrillas, Stark walked back to friendly territory, encountering downed chopper pilot JIM RHODES™ in the process. Stark kept the armor after his escape, trimming it to allow the life-maintaining pacesetter to keep this heart beating. Stark would have to wear the armor chestplate until he was implanted with an artificial heart years later. The original suit of Iron Man armor is believed destroyed by Jim Rhodes following the takeover of Stark International by Stane.

## IRON MAN™ ARMOR

Golden Avenger Armor

**Availability:** Unique

**Constructed by:** Stark International

**Inventor:** Tony Stark

**Worn by:** James Rhodes

F A S E R I P  
Gd Gd Ty Ty Gd Ex Ty

### ABILITY MODIFIERS

Raises Fighting by 2 ranks  
(Maximum of EXCELLENT)

Raises Agility by 2 ranks  
(Maximum of EXCELLENT)

Raises Strength by 5 ranks  
(Maximum of INCREDIBLE)

Raises Endurance by 6 ranks  
(Maximum of MONSTROUS)

### KNOWN POWERS

#### BODY ARMOR

- Electric-powered, iron-alloy, molecular-scale chain mail maintained by an enclosed magnetic field. Made of Remarkable material bolstered by the magnetic field to Amazing material when in operation.
- Provides Amazing protection from physical damage.
- Provides Amazing protection from most energy attacks.
- Provides Unearthly resistance to radiation.
- Provides Remarkable resistance to heat, cold, and acid.
- Provides Unearthly resistance to electrical attacks.





## **FLIGHT**

- High-speed gyro-stabilized turbines located in the boots.
- Normal flight at Monstrous speeds, 9 areas per round normally, up to a maximum of 30 areas.
- Boot-jets may be used as weapons, inflicting Incredible damage against targets in the same area.

## **REPULSORS**

- Medium-density plasma projectors located in each gauntlet. Outlet located in palm of gauntlet.
- Range of 10 areas.
- May inflict up to Amazing damage. May inflict less at the discretion of the user.
- May be fired at separate targets (red FEAT, yellow for Tony Stark, Jim Rhodes), for up to Amazing damage, no target may receive more than Amazing damage.

## **UNIBEAM**

- Chest-mounted high-intensity lamp.
- Illuminates an area up to 3 areas away.
- Turned on suddenly, may blind an opponent facing the wearer for 1-10 rounds (Endurance FEAT roll to avoid). This light is of Remarkable intensity.
- The beam may be narrowed to produce a laser. This laser has a 3-area range and inflicts Incredible damage (may not be lowered).
- Illumination from the unibeam extends into the ultraviolet and infrared bands of the spectrum.

## **AIR SUPPLY**

- Fully-functional life-support system capable of functioning underwater and in vacuum for 2 hours.
- Internal indicators and bell warns of potential failure or exhaustion of air resources.

## **FIRE EXTINGUISHER**

- Foam sprayer contained within the armor reduces fire by a Remarkable degree, eliminating fires of less than Incredible intensity.
- Range of fire extinguisher is 1 area.
- Foam may be sprayed over armor to further reduce heat damage by 1 rank.

## **ENERGY ABSORPTION**

- Internal circuitry of the suit may absorb up to an Unearthly amount of energy each round.
- Three rounds of Unearthly electrical energy, or 300 points of potential damage, may be so stored.
- Further storage causes the storage pods to overload for Monstrous damage to all in the same area.
- Stored energy may be redirected through the repulsors or unibeam, inflicting Monstrous damage each round until the stored energy is depleted.
- The circuitry of the energy systems may be modified to absorb other forms of energy. This requires a Reason of at least Incredible.

## **ENERGY PODS**

- Excess energy is stored in two disk-like pods attached to the waist.
- Detached from the belt, but linked by cables, these pods may generate a broad-spectrum induction field. This field may:
  - Act as a Remarkable strength force field.
  - Overload electronic circuitry with Excellent intensity. Those electrical items without an Endurance rank are overloaded on a green FEAT roll.
- Fully detached from the armor, the pods may be thrown up to 5 areas, exploding for Amazing damage in a single area.
- If one pod is detached, reduce the wearer's Strength, Endurance, and maximum damage by one rank. If both pods are detached, reduce these abilities by two ranks. Excess electrical energy may not be stored if both pods have been detached.

## **OVERRIDE**

- The armor is equipped with internal safety mechanisms to prevent overloading of designed systems. These interfaces may be consciously bypassed to increase abilities.
- Strength or repulsor damage may be raised to Unearthly in this fashion.
- Any other single ability may be raised by a single rank through override.
- Each round of override, the owner of the armor must make a yellow FEAT roll on the Shift 0 column.
- Failure indicates the armor is immobilized and must be repaired.

## **SONIC ATTACK**

- Mechanisms within the helmet may project an omni-directional high-frequency sound wave.
- Range of 3 adjacent areas.
- Sonic attack may inflict up to Amazing damage to all within those areas.
- In addition with affected areas must make an Endurance FEAT roll against the intensity of the attack, or be Stunned for 1-10 rounds.

## **TRACTOR BEAM**

- The armor has a small tractor beam located in the chest plate.
- Lifts objects as Good strength.
- Range of 1 area.

## **NIGHTVISION LENS**

- Inset in helmet.
- Nightvision lens allows the wearer to see in normal darkness up to 3 areas away.

## **SENSORS**

- Radar/sonar/heat detection sensors implanted in armor and helmet.
- Range of 10 areas.
- Vital signs detector which may be keyed to specific individuals in advance. Range of ten miles.
- Exotic energy detector, capable of detecting odd or unusual radiation, range of ten miles.

## **FREON TABLETS**

- Super-cooled tablets of freon gas are mounted in dispensers in the epaulets of the armor.
- May be used against targets in close contact.
- Inflicts Monstrous cold damage. Will supercool metal and inflict the same damage on machinery.

## **MULTI-BAND RADIO**

- AM/FM, short wave, civilian, and navigation bands may be monitored through the helmet.
- Receives own wavelength and those of defense organizations, including S.H.I.E.L.D.
- May tie in with satellite and computer networks.
- Has emergency beeper.
- Range on all of above, 200 miles.

## **SONIC DISTORTER**

- Installed in the throat of the helmet, this mechanism cuts out the high and low frequencies of the wearer's voice, hiding the owner's identity.
- Further scrambling negates the effects of electronic voice-detectors and similar devices with Amazing ability.

## **ELECTRONIC COUNTER MEASURES**

- Electronic Counter Measures are installed in the suit, providing Good protection from electronic detection.
- The suit is also equipped with high-quality internal security, such that the wearer has Monstrous protection from outside interference of his or her armor's performance.

## **REVERSE MAGNETISM**

- Reverse magnetism generators are installed within the armor's gauntlets.
- This circuitry provides Incredible control over magnetism.

## **ROLLER SKATES**

- Roller skates are installed within the boots of the armor.
- The wearer can reach maximum speed of Incredible (7 areas/round) using the skates on a smooth surface.

## **EYE PROTECTION**

- Polarized eye shields installed in the helmet drop into place to protect the wearer from being blinded by bright lights.
- Sudden polarization causes 1 round of blindness.

## **IMAGE PROJECTION**

- The armor may project up to a dozen visual images of Iron Man which match the actions of the original.
- Any attack on the wearer of the suit has an equal chance of hitting a duplicate.
- This illusion is one of light manipulation only. Radar, scent, or detection of life energies reveals the true location of the user.

### DIGGING ABILITY

- The gauntlets may be fitted with rotated studs capable of boring through earth.
- The suit's user may move at Good speed through soil and rock of up to Good material.

### BRIEFCASE

- The suit of armor may be stored in what appears to be a normal briefcase, but which has been specially constructed to contain the armor.
- The briefcase is made of Remarkable material.
- It is secured by an Amazing complexity lock.
- Failure to foil the lock sets off an Amazing strength bomb which destroys the armor completely.

### DESIGN NOTES

This was the suit of armor used by Tony Stark at the time of Stane's takeover of Stark International, and was passed on to pilot James Rhodes when Stark's alcoholism prevented him from acting as Iron Man. It represents the ultimate technology created by Stark International until then, coupling Stark's ingenuity with the resources available from the multinational corporation. Iron Man kept several suits of this type, as well as earlier prototypes in his lab in the industrial complex. These duplicates were believed destroyed by Rhodes. Rhodes served as Iron Man while Tony was incapacitated, and retained the armor with Stark's creation of his newest set (See Silver Sphinx Armor) Rhodes doubts he will use the armor again since Stark is back as Iron Man.

### IRON MAN™ ARMOR



**Availability:** Unique

**Constructed by:** Tony Stark/CIRCUITS MAXIMUS

**Inventor:** Tony Stark

**Worn by:** Tony Stark

F A S E R I P  
Ty Ty Pr Ty In Ex Ty

### ABILITY MODIFIERS

- Raises Fighting by 2 ranks (Maximum of EXCELLENT)
- Raises Agility by 3 ranks (Maximum of REMARKABLE)
- Raises Strength by 5 ranks (Maximum of INCREDIBLE)
- Raises Endurance by 6 ranks (Maximum of MONSTROUS)

### KNOWN POWERS

#### BODY ARMOR

- Electric-powered, iron-alloy, molecular-scale chain mail maintained by the magnetic field. Armor is made of Remarkable material, bolstered by a magnetic field to Amazing material when in operation.
- Amazing protection from physical damage.
- Monstrous protection from most energy attacks (see below)
- Unearthly protection from radiation.
- Amazing resistance to heat and cold.
- Incredible resistance to acid.
- Unearthly resistance to electrical attacks.

#### FORCE FIELD

- Created by a "hardening" of the magnetic field, shunting power from other systems.
- May be used only 1 round per hour safely (see Overrides).
- Raises body armor for Slugfest and concussive damage to Monstrous.
- Raises resistance to energy attacks to Unearthly.
- Repulsor and other weapon or detection systems may not be used when force field is in operation.

#### FLIGHT

- High-speed duo-source turbines located in boots.
- Normal flight of 10 areas per round, maximum of 30 rounds.
- May reach Unearthly speeds (50 areas/round) outside the atmosphere.
- Turbines have a high efficiency, and can function at the very borders of the atmosphere.
- If used as weapons, the boots inflict Incredible damage to targets in the same area.

#### REPULSORS

- Medium density plasma projectors located in each gauntlet, outlet located in palm.
- Range of 10 areas.
- Inflicts up to Amazing damage. May inflict less at the discretion of the user.
- May be fired at separate targets (see note under Golden Avenger armor).

### PULSE-BOLTS

- High-density pulsed plasma projectors located in the wrist of each gauntlet.
- Range of 10 areas.
- Inflicts Monstrous damage. May not inflict less than Monstrous damage, and may disintegrate materials of Remarkable or less material.
- May not be fired at separate targets.

### UNIBEAM

- Chest-mounted high-intensity lamp.
- Illumination up to 3 areas away.
- May blind an opponent using Remarkable intensity.
- Beam may convert to laser/energy release, inflicting Amazing damage up to 3 areas away.
- Illumination of unibeam extends into the ultraviolet and infrared bands of the spectrum.

### THERMAL BEAM

- Also a component of the chest-plate assembly, the thermal beam is a high-intensity heat beam.
- May inflict Incredible damage up to 3 areas away.
- Will melt metals of less than Incredible material strength.

### DISRUPTOR FIELD

- Generated from gauntlets, may be directed up to 2 areas away.
- Overloads electronic equipment and guidance systems with Remarkable intensity. Electrical equipment without an Endurance rank is overloaded on a green FEAT roll.

### ENERGY ABSORPTION

- Circuitry may absorb up to an Unearthly amount of energy each round for 4 rounds.
- Up to 4 rounds of Unearthly rank energy, or 400 points of potential energy damage, may be so stored.
- Stored energy may be redirected through the unibeam or other weapon systems, inflicting up to Monstrous damage until the excess is depleted.
- Stored energy retained beyond 4 rounds can damage circuitry. Make an Endurance FEAT roll or energy is discharged, inflicting Good damage on the wearer.
- All forms of non-concussive energy may be stored within the armor, including heat and light energy.

### AIR SUPPLY

- Fully functional life-support systems may function for an undetermined period underwater and in a vacuum.
- High-efficiency reproducers may result in total environmental independence for an unlimited period of time.

## ENERGY STORAGE

- Unlike previous versions, energy is stored within the suit's circuitry, such that individual parts of the suit retain a "charge" if separated from the rest.
- Enough "charge" remains in a disconnected gauntlet to fire one repulsor beam of Amazing strength.
- Enough "charge" remains in a boot unit to fly with Good speed for 5 rounds.
- Enough "charge" remains to power all helmet operations normally.
- The chest unit needs no residual charge, and may operate normally.

## OVERRIDE

- As with previous versions, the newest suit may be overridden by removal of the safety interfaces.
- Strength or repulsor damage may be raised to Unearthly by overriding existing systems.
- All other systems may be overridden by a single rank.
- Each round of override, the wearer must make a yellow FEAT roll on the Feeble column.
- Failure indicates the armor is immobilized and must be repaired.

## DETECTION EQUIPMENT

- Nightvision lens as Golden Avenger armor.
- Radar/Sonar/Heat detection sensors as Golden Avenger armor.
- Vital sign and exotic energy detector as Golden Avenger armor.
- Scanner program is keyed to particular typical threats (missiles, bombs), functioning at the Remarkable level.
- Energy detection equipment allows the wearer to "see" hidden electrical cables and equipment up to 1 area away, noting their power flow through up to Remarkable material.

## MULTI-BAND RADIO

- As for Golden Avenger armor.

## SONIC DISTORTER

- As for Golden Avenger armor.

## ELECTRONIC COUNTERMEASURES

- Electronic Countermeasures provide Remarkable protection from electronic detection, including radar.
- The Iron Man armor has Unearthly protection from signals designed to take control of the armor and interfering with its performance.
- An implanted holographic projector in the armor allows the suit to blend in with the background. While not invisible, this provides Remarkable protection from visual sighting. Against complex backgrounds, the projector only provides Good protection against being seen.

## EYE PROTECTION

- As for Golden Avenger armor.

## FURTHER ABILITIES

- It is not known if the suit has further abilities, modifications, or improvements of abilities available in earlier sets (such as reverse magnetism, freon tablets, or roller skates). Further abilities may be made known as time goes by.

## DESIGN NOTES

After regaining control of his life and his drinking problem, Stark, along with Rhodes, end the Erwins (Morley and Clymnestra) set up shop in California, calling their new company Circuits Maximus. Stark began recreating his armor (his original set in Rhodes' hands) as a method of working out ideas and experimenting. The S-circuit, which uses its energy more efficiently, is an example of the breakthrough developed by Stark, using the armor as a model. With the destruction of Circuits Maximus by Obadiah Stane, (and the resulting death of Morley Erwin), Stark donned the newest set of armor to battle the foe that stripped him of his business, his friends, and almost his life. The battle with Stane was the first field test of this armor, and resulted in the defeat of Stane and the destruction of Stane International. Stark serves as Iron Man in this armor.

## IRON MAN™ ARMOR

Space Armor

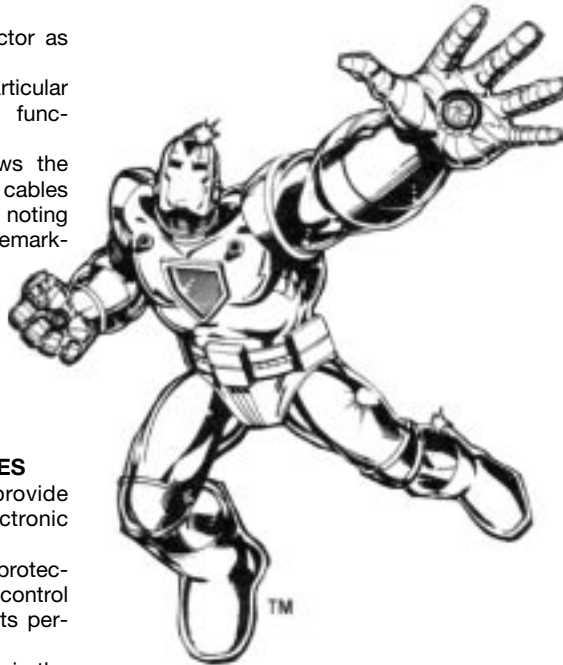

**Availability:** Unique, believed destroyed

**Constructed by:** Stark International

**Inventor:** Tony Stark

**Worn By:** Tony Stark (See Iron Man Armor, Golden Avenger Armor)

## ABILITY MODIFIERS

Raises Fighting by 1 rank  
(Maximum of EXCELLENT)

Raises Agility by 1 rank  
(Maximum of GOOD)

Raises Strength by 6 ranks (Maximum of MONSTROUS)

Raises Endurance by 7 ranks (Maximum of UNEARTHLY)

## KNOWN POWERS

### BODY ARMOR

- Similar design to the Golden Avenger armor, except for extreme additional protection for space travel.
- Provides Amazing protection from physical damage.
- Provides Amazing protection from most energy attacks.
- Provides Unearthly resistance to radiation and electricity.
- Provides Monstrous resistance to heat and cold.
- Provides Remarkable resistance to acid.

### REPULSORS

- Inflicts Monstrous damage at range of 15 areas

### FLIGHT

- Conventional boot thrusters allow atmospheric movement at 8 areas per round.
- In space, nuclear thrusters allow movement at 50 areas per round.
- These nuclear thrusters may inflict Unearthly energy and radiation damage when in the atmosphere.

### VARIO-BEAM SPOTLIGHT

- A variation of the unibeam spotlight.
- May provide illumination up to 15 areas away.
- May command a deflector beam capable of pushing against an object with Monstrous strength.

### EXO-UNIT GAUNTLETS

- Extendible gauntlets may be jettisoned as grappled up to 7 areas away, and manipulated as if part of the armor.
- Because of the weak mooring line, these gauntlets may only be used in zero-gravity conditions.

### AIR SUPPLY

- The Space Armor contains 4-5 weeks of recyclable food, water, and air.

### ELECTRONIC COUNTERMEASURES

- Electronic Countermeasures are as for the Golden Avenger armor.
- ECMs do not operate when using the nuclear thrusters.

### DETECTION EQUIPMENT

- As for Golden Avenger armor.
- Includes camera capable of withstanding vacuum.

### COMMUNICATION EQUIPMENT

- As for the Golden Avenger armor, with 2,000-mile radius.

## DESIGN NOTES

The Iron Man Space Armor was developed by Tony Stark as one of the specialized suits designed for certain missions, in this case, those occurring in the earth's orbit beyond the reach of the normal air-breathing turbines of the standard suit (for long missions in space, a modified AVENGERS QUINJET™) is usually used. The suit was used once to investigate the sudden death of an entire midwestern town—deaths resulting from an accident aboard a secret Roxxon solar-powered space station. Stark donned the space armor to investigate and first encountered SUNTURION™ there. The station fell out of orbit, and only the actions of Iron Man and Sunturion together prevented the destruction of Sarasota, Florida. Sunturion apparently perished in the rescue attempt.

The Iron Man Space Armor is believed destroyed by Jim Rhodes.

## IRON MAN™ ARMOR

Stealth Armor



**Availability:** Unique, believed destroyed

**Constructed by:** Stark International

**Inventor:** Tony Stark

**Worn by:** Tony Stark (see Iron Man Armor, Golden Avenger Armor)

## ABILITY MODIFIERS

Raises Fighting by 2 ranks  
(Maximum of EXCELLENT)

Raises Agility by 3 ranks  
(Maximum of REMARKABLE)

Raises Strength by 5 ranks  
(Maximum of INCREDIBLE)

Raises Endurance by 6 ranks  
(Maximum of MONSTROUS)

## KNOWN POWERS

### BODY ARMOR

- Less effective than standard suits of that time.
- Provides Remarkable protection against physical and energy attacks, including fire, cold, radiation, and acid.

## FLIGHT

- May reach 11 areas per round while traveling cross-country in clear air.
- Usually travels Amazing speed (8 areas/round) when engaged in secret missions, following MOE (Map of Earth—close to surface).
- Jet-boots may be used offensively, with a range of 1 area, for Remarkable damage.

## REPULSORS

- The Stealth armor has no repulsor units.

## SENSORS

- Standard radar/sonar package as with Golden Avenger armor.
- Active x-ray scanner, range of 1/2 mile.
- Active deep sound scanner, range of 1/2 mile.
- Camera equipment including infrared film.

## ELECTRONIC COUNTERMEASURES

- Monstrous protection from radar and other “active” detection systems. An active system (such as radar) sends a wave to a target and notes any “bounce-back.” The armor warps this wave, producing no returning “blip.”
- The jet-boots are baffled to prevent any sonic detection.
- Non-reflective black coating provides Good protection from visual or mechanical detection, at a cost of lower resistance to energy.

## DESIGN NOTES

Stealth armor is another of the specialized suits of armor developed by Tony Stark for specific missions, similar to the Space armor. Stealth armor was designed using current “stealth” technology to allow Iron Man to foil detection devices and slip unknown in and out of restricted areas. This addition to ECMs, detectors, and speed was accomplished at the price of lowered protective capabilities and the elimination of any offensive weapons.

The stealth armor was used once to rescue BETHANY CABE™ undetected from East German territory and the hands of the LIVING LASER™. While the armor failed in this attempt, it was rebuilt and modified. It was believed destroyed by Jim Rhodes after Obadiah Stane took over the company.

## BATTLESUIT, STANDARD (FENRIS™)

**Availability:** NA/2,500r

**Constructed by:** Various firms

**Inventor:** Various

**Worn by:** Various lackeys

F A S E R I P  
Ex Gd Ty Ty Ty Ty Ty

## ABILITY MODIFIERS

Raises Strength by 3 ranks  
(Maximum of REMARKABLE)

Raises Endurance by 4 ranks  
(Maximum of INCREDIBLE)

## KNOWN POWERS

### BODY ARMOR

- Usually constructed of some high-strength steel alloy.
- Provides Incredible protection against physical attacks.
- Provides Remarkable protection against energy attacks, including heat cold, and radiation.

## FLIGHT

- High-speed turbine-thrusters located in the boots.
- Normal flight at 7 areas per round
- If used as weapons, inflict Good damage against a target in the same area.

## WEAPON SYSTEMS

- This type of armor has a choice of three distinct weapon systems Only one may be used on any set of armor.
- OPTION I: Internal blasters of 4-area range, inflicting Remarkable damage.
- OPTION II: External hand held concussion rifle with 6-area range, Incredible intensity Slugfest attack.
- OPTION III: “Thunder Puncher” combat enhancer, allowing the user to strike with Monstrous strength in combat.

## DESIGN NOTES

The above is a standard battlesuit used by subversive operatives, made available through less-than-honest arms dealers. This set is based upon those used by Andrea and Andreas Strucker, children of the late leader of HYDRA, BARON STRUCKER™. These suits went up against the X-MEN™, but were really no more than a delaying tactic while the Struckers attacked MAGNETO™, PROFESSOR X™, and GABRIEL HALLER™.





**BEETLE™ ARMOR**



**Availability:** Unique  
**Constructed by:** ABNER JENKINS™  
**Inventor:** Abner Jenkins and THE TINKERER™  
**Worn by:** Abner Jenkins

F A S E R I P  
 Gd Gd Ty Ty Ex Rm Ty

**ABILITY MODIFIERS**

Raises Strength by 2 ranks  
 (Maximum of EXCELLENT)  
 Raises Endurance by 2 ranks  
 (Maximum of EXCELLENT)  
 See Battle Computer for further modifications.

**KNOWN POWERS**

**BODY ARMOR**

- Constructed of reinforced magnanium and powered by ambient microwaves.
- Provides Excellent protection from physical attacks.
- Provides Remarkable protection from energy attacks, including heat and cold.
- As the suit is a powerful source of microwave energy, transmissions such as radio and television will jam within 3 areas of the user.

**POWERBOOST**

- If close to a source of microwave radiation, the user may further boost the suit's Strength in terms of lifting ability to Remarkable. This does not effect the total Health.

**WALL CRAWLING**

- The gloves of the Beetle armor are equipped with pneumatic suction-grippers.
- The armor's user has Excellent control on vertical surfaces.

**FLIGHT**

- The armor is equipped with mylar wings (Good strength material) powered by DC micro-motors, and controlled by cybernetic command.

- May fly at Excellent (5 Areas) speed.
- If power is diverted from weapon systems and battle computer (rendering them useless), speed may reach 10 areas per round.

**BATTLE COMPUTER**

- Mini-computer built into the armor's chestplate.
- If fed with proper programming, the Beetle armor may anticipate moves by an opponent, effectively increasing the Beetle's Fighting and Agility scores against that opponent.
- Fighting is raised by 2 ranks.
- Agility is raised by 2 ranks.
- Programs exist on Iron Man, DARE-DEVIL™, Spider-Man, and CAPTAIN AMERICA™.

**ELECTRO-BITE**

- Installed in the gauntlets of the armor, this electro-static blast may only be fired if both hands are free.(Beetle fires by placing the second and third fingers together, aiming with the first and fourth finger.)
- Range of 10 areas.
- Inflicts up to Excellent electrical damage.
- The user may increase this to Remarkable damage by drawing on power from the wings and battle computer (if the wearer does this, he or she does not benefit from the computer's programs when firing, and also plummets to the ground if airborne.

**DESIGN NOTES**

Abner Jenkins was a master mechanic trapped in a menial job who build the Beetle armor in his spare time to engage in criminal activities. The original Beetle armor was used against several super-powered foes, but was partially destroyed by Iron Man in the same battle that claimed PORCUPINE'S™ original suit. Following his defeat, Beetle resigned and updated his equipment, though he still needs to use both hands to fire his electro-bite.To collect the data he needs on his super-powered opponents, Beetle has been known to trade in information and to force other foes (such as RINGER™) into battle with his opponents while he observes.

**BLIZZARD™ BATTLESUIT**

**Availability:** Unique  
**Constructed By:** GREGOR SHAPANKA™  
**Inventor:** Gregor Shapanka  
**Worn by:** Gregor Shapanka

F A S E R I P  
 Ty Gd Gd Ex Rm Gd Pr

**ABILITY MODIFIERS:** None

**KNOWN POWERS**

**BODY ARMOR**

- Fully insulated battlesuit with additional padding.
- Provides Good protection from physical damage.

- Provides Amazing protection against cold.

**ICE PROJECTORS**

- Miniature cryogenic units set in the gloves and powered by circuitry in backpack.
- Backpack also contains water reserves and is made of Remarkable strength material.
- May generate snow, sleet or ice at the Remarkable level.
- May provide the wearer with body armor of Remarkable strength.
- May encase others with Remarkable strength ice, and form ice walls of Remarkable strength.
- May create icy missiles with range of 3 areas and inflicting Remarkable damage.

**DESIGN NOTES**

Gregor Shapanka was a research scientist for Stark International who was dismissed for selling company secrets. Using his Own abilities, Shapanka created his cold-generating suit end took to crime, first as JACK FROST™, and later as Blizzard. Blizzard was slain by a mysterious assailant, but his suit and plans survive him.



**BOX™ ARMOR**  
Second Version



**Availability:** Unique  
**Constructed by:** MADISON JEFFRIES™/  
 ROGER BOCHS™  
**Inventor:** Roger Bochs and James Hudson  
**Worn by:** Roger Bochs

F A S E R I P  
 Pr Pr Ty Gd Ex Gd Gd

**ABILITY MODIFIERS**

Because of the nature of Box armor, abilities are not modified, but changed.

Fighting is REMARKABLE level.  
 Agility is REMARKABLE level.  
 Strength is MONSTROUS level.  
 Endurance is MONSTROUS level

**KNOWN POWERS**

**BODY ARMOR**

- Constructed of “living metal” an invention of Roger Bochs.
- Provides Amazing protection from physical and energy attacks.
- Provides Monstrous protection from heat, cold, and radiation.

**FLIGHT**

- Jet-thrusters are built into the legs of the Box armor.
- Fly up to Excellent (5 areas/round) speed.
- If used as weapons, the boot-jets inflict Remarkable damage to a target in the same area.

**LEAPING**

- The super-strong metallic muscles of the Box armor can bound up to 4 stories up and 2 areas away in a single leap.

**MERGING**

- The Box armor is entered by physically merging the user’s body into the living metal.
- This merging takes 1 round.
- Damage to the Box armor inflicts psychic anguish, but no real damage, to the wearer.
- Catastrophic damage (loss of a limb), results in unconsciousness for use, Red Psyche FEAT roll to avoid.
- There is a danger of living beings being trapped within the Box armor. Make Endurance FEAT roll for every hour above three to allow the user to leave the Box armor. This limitation does not apply to those without physical bodies.
- Only Bochs may physically merge with his armor.

**REPAIR**

- Because of the nature of the “living metal” the best repairman for Box armor is Madison Jeffries, who can manipulate metals and mechanisms at will.

F A S E R I P  
 Ty Ty Ty Rm Gd Gd Rm

- Jeffries has Unearthly control over metals and mechanisms, and may bend them to his will.
- Jeffries may heal damage done to the Box armor at an Unearthly rate, but Box armor must be out of combat or not active for him to do so.

**COMMUNICATION AND COMPUTER LINK**

- The Box armor is built to allow the user to tap into available computer hardware, tapping directly into the machine.
- The armor also has standard radio gear with a 200-mile range across all standard bands.
- This radio gear may issue a jamming signal of Incredible intensity in a range of 5 areas.

**SENSORS**

- The Box armor’s sensors span the complete electromagnetic spectrum from microwaves to hard radiation.

**DESIGN NOTES**

Roger Bochs is the handicapped engineer and inventor who first proposed the Box armor as a method of regaining his lost limbs JAMES MACDONALD HUDSON™, leader of ALPHA FLIGHT™, was interested in the armor and recruited Bochs into his department H. Bochs and Box armor quickly rose through Gamma flight and was in Beta Flight when the government folded. Bochs returned with his invention, now more fully developed with Hudson’s help, to his home in Moosejaw, Saskatchewan.

At home, Bochs was contacted by DELPHINE COURTNEY™, acting as an agent for Jerry Jaxon and his OMEGA FLIGHT™. Bochs went along with Courtney’s proposal to form an opposing team to Alpha Flight to see how involved other members of

Beta and Gamma Flights were. Bochs did not agree to the proposed death of Hudson and his team, and as a result had the Box armor taken from him. At that time, the armor was controlled by an internal link and Jaxon used that link to destroy Hudson.

Bochs escaped in the confusion following the battle, angry at himself for letting the armor be used in such a fashion and angrier still that it resulted in the death of Hudson, whom he liked and respected. Contacting another member of Gamma Flight, a metamorph named Madison Jeffries, Bochs set about building another Box armor, this one to be used as a tool against Omega Flight. To avoid the problem of being controlled from the outside, this version of the armor would be physically entered, merging the user’s body to the armor.

This facet of the armor proved very useful when Walter Langkowski, SASQUATCH™ of the team, lost his physical body Langowski’s body was housed in Box armor, until a better body was found. Bochs and Jeffries worked up a mystical dimension scanner with the help of SHAMAN™ and found a mindless body at the Crossroads of All Realities. This body proved to be the HULK™, who escaped back into our dimension as a result. Langkowski’s spirit has vanished and Bochs again used the Box armor himself.

**CALIBER BATTLESUIT**



**Availability:** Unknown  
**Constructed by:** Unknown  
**Inventor:** Unknown  
**Worn by:** Unidentified Terrorist

F A S E R I P  
 Gd Gd Gd Gd Ty Ty Ty

**ABILITY MODIFIERS**

Raises Fighting by 2 ranks  
 (Maximum of REMARKABLE)  
 Raises Agility by 1 rank  
 (Maximum of EXCELLENT)

Raises Strength by 2 ranks  
(Maximum of REMARKABLE)  
Raises Endurance by 4 ranks  
(Maximum of INCREDIBLE)

**KNOWN POWERS**

**BODY ARMOR**

- State-of-the-art, presumably tool steel alloy construction.
- Provides Incredible protection from physical attack.
- Provides Amazing protection from most energy attacks.
- Provides Monstrous protection from radiation, heat, and cold.

**FISSION BLASTER**

- Installed in right arm of suit.
- May inflict up to Remarkable damage up to 10 areas away

**PARTICLE ACCELERATOR**

- Installed in left arm of suit.
- May inflict up to Incredible damage up to 3 areas away

**MISSILE RACK**

- Carried on back of armor.
- Carries a variety of charges and loads.
- Monstrous strength explosives.
- Amazing strength incendiaries.
- Remarkable intensity knock-out gas.
- Range of missiles is 15 areas. Missiles affect all within the target area.

**AIR SUPPLY**

- The Caliber armor has a self-contained air supply that lasts up to 6 hours.

**DESIGN NOTES**

Not much is known of the Caliber armor, but it is typical of the type created by individuals who believe that all you need to be a super-powered villain is a flashy suit and a list of demands. It is heavy in firepower, but light in protection, particularly protection from specialized attacks. Caliber armor first appeared in the streets of Vancouver, where the wearer was defeated by Alpha Flight. A few days later, someone (presumably Omega Flight) sprung the criminal, apparently as a plot to introduce a bogus GUARDIAN™ into the group. Caliber was defeated a second time and the armor destroyed, but whether further versions of this type of armor exist are unknown.

**CONSTRUCTOR BATTLESUIT**

**Availability:** Unique  
**Constructed by:** The Corporation  
**Inventor:** Unknown  
**Worn by:** FRANK SCHLICHTING™

F A S E R I P  
Gd Gd Gd Ex Pr Gd Gd

**ABILITY MODIFIERS:** None

**KNOWN POWERS**

**BODY ARMOR**

- Fully insulated battlesuit with partial bullet-proofing.



- Provides Good protection from physical damage.
- Provides Remarkable protection from energy attacks.
- Provides no significant protection from other forms of energy attack.

**ADAMANTIUM CABLES**

- Two adamantium alloy cables, one in each wrist of the suit. They are Unearthly strength materials.
- May reach into any adjacent area.
- A successful wrestling attack indicates the coils have wrapped about the target inflicting Remarkable constriction damage.
- While unbreakable, a successful Escape FEAT roll indicates the bonds have been loosened sufficiently to slip out.
- Once ensnaring a victim, the wearer may send electricity through the cables from a power pack located in the chest inflicting Monstrous electrical damage.
- If used as whips, the cables may inflict up to Incredible damage up to 1 area away.

**CYBERNETIC CONTROL**

- Located beneath the padded crown of the battlesuit's cowl
- Allows the wearer to extend and retract the coils at will, as well as vent power through them.
- Has Amazing ECM to prevent outside takeover of the suit's firepower.

**DESIGN NOTES**

The Constrictor battlesuit was developed by the now-defunct criminal organization known as the Corporation, headed by Eugene Kligger Stivak (see TORPEDO™ armor). Frank Schlichting was a small-time hood who applied to the Corporation for work, and was outfitted in the suit and employed as a hit man. With the defeat of the Corporation by Captain America and the Hulk, Schlichting went freelance, working for whoever would pay. After a rocky career as a super-powered criminal, Schlichting was severely beaten by ANACONDA™. He is now hospitalized.

**CREDIT CARD SOLDIER™ ARMOR**



**Availability:** NA/5,000r  
**Constructed by:** Agents of Soviet Union  
**Invented by:** "Sergei" a soviet scientist  
**Worn by:** Former US combat veterans

F A S E R I P  
Ex Gd Gd Ex Gd Gd Gd

**ABILITY MODIFIERS**

Raises Fighting by 2 ranks  
(Maximum of INCREDIBLE)  
Raises Agility by 1 rank  
(Maximum of REMARKABLE)  
Raises Strength by 2 ranks  
(Maximum of REMARKABLE)  
Raises Endurance by 2 ranks  
(Maximum of INCREDIBLE)

**KNOWN POWERS**

**BODY ARMOR**

- Constructed of unspecified steel alloys using American-made circuitry.
- Provides Remarkable protection against physical damage.
- Provides Incredible protection against energy attacks, including heat, cold, and radiation

**BLASTERS**

- Variable setting pulse-laser.
- Inflicts up to Excellent damage up to 8 areas away.

- Carried separately from the suit, but takes its power from the armor.

### SENSORS

- Full-band energy and life-detection sensors, 3-area range.
- Internal identification scanners are programmed with near-complete listing of established super-powered individuals. The wearer's Reason is Incredible to identify such individuals and further enhancement may grant details of known points of career.
- Scanning program also gauges soldier's capabilities against target, providing recommendations on tactics.

### "CARD SHUFFLE"

- The armor, and those within, may be reduced to small squares of plastic the size and shape of credit cards (hence the armor's name).
- This change may be effected by another party with an external control module set to that frequency.
- While in the card-Like state is vulnerable (Typical strength material).

### FLIGHT

- Powered boot-jets allow the credit-card armor high speeds for short distances.
- Maximum speed is 7 areas per round, but internal fuel allows flight for only 10 rounds.
- Long-distance travel is handled by a third party moving them in credit-card state.

### DESIGN NOTES

The Credit Card Soldier armor was developed by the expatriot Soviet scientist known as Sergei, whose parents were being held by government in his home country. Under the orders of the TITANIUM MAN™, Sergei developed both the armor and the credit card technology used in that armor and in the Titanium Man's armor. Posing as the COMMANDER™, Titanium Man recruited a band of disaffected Vietnam veterans to form the GREEN LIBERATION FRONT™, dedicated to the purposes of truth, justice, and making a lot of money.

Under the "Commander," the GLF raided Wall Street, only to be stopped by BETA RAY BILL™ and SIF™. The Commander entered the fray, and was revealed as the Titanium Man. The GLF turned on their former leader when they realized they had been duped by a Communist agent, and nearly defeated the Titanium Man. Following the battle, Beta Ray Bill, given an control console by Sergei, convinced the remaining members of the GLF to ditch their armor to avoid being permanently "carded." The whereabouts of the GLF, Sergei, or the Credit Card Soldier suits are currently unknown.

### CRIMSON DYNAMO ARMOR

**Availability:** Unique

**Constructed by:** CORDCO

**Inventor:** ANTON VANKO™

**Worn by:** DIMITRI BUKHARIN™, KGB Agent



F A S E R I P  
Rm Ex Gd Ex Ty Ex Gd

### ABILITY MODIFIERS

- Raises Agility by 1 rank (Maximum of REMARKABLE)
- Raises Strength by 3 ranks (Maximum of INCREDIBLE)
- Raises Endurance by 5 ranks (Maximum of MONSTROUS)

### KNOWN POWERS

#### BODY ARMOR

- Constructed of carborundium-matrix alloy.
- Provides Amazing protection from physical damage.
- Provides Amazing protection from most energy attacks
- Provides Amazing resistance to fire, radiation, heat, and cold.

#### FLIGHT

- Thrust provided by two chemically-fueled turbo-fan jets located in each boot.
- May fly up to 8 areas per round.

#### BLASTERS

- Powered by electronic circuitry on a separate line from the boot jets.
- Produces lightning-Like discharge capable of inflicting up to Incredible electrical damage up to a range of three areas.

#### AIR SUPPLY

- The armor possesses up to 1 hour of self-contained air for the wearer.

#### POWER OVERRIDE

- The Dynamo armor may be overridden to produce a one-shift raise in Strength, or

two-shift raise in damage, if connected with a more powerful power-source (example, a generator)

- The armor lacks sufficient power to increase abilities without external help.

### DESIGN NOTES

This is the second set of Crimson Dynamo armor, based on the plans of Soviet scientist Anton Vanko. Vanko built the original set to battle Iron Man on behalf of his government, but defected after his defeat by the Golden Avenger. Soviet agent Boris Turgenov stole the armor from Vanko and both men died in the ensuing battle, rendering the armor useless.

The present set of Crimson Dynamo armor was constructed by Alex Nevsky, Vanko's former research assistant, at Cord Industries, to be used as a tool of vengeance against Iron Man. Vanko's other assistants and technicians were sent to a work camp in Siberia following Vanko's defeat (see Titanium Man). Nevsky was defeated, fled to the Orient where he was assassinated by Soviet agents who recovered the armor for their country. A case may be made for Cord Industries taking the armor, but this corporation had its own problems (see Mauler, Raiders) and was bought by Stark International.

Since its recovery by the Soviets, the Dynamo armor has been worn by Yuri Petrovich on a mission to America (a failure, Petrovich has been sent to a work camp) and most recently KGB Agent Dimitri Bukharin. After working briefly with the SOVIET SUPER SOLDIERS™, Crimson Dynamo is now a solo operative of the Soviet government and KGB.

Despite its updating by Nevsky, the Crimson Dynamo is an outdated battlesuit with inferior technology. Whether its weapon systems will be updated further is uncertain.

### DEVASTATOR™ BATTLESUIT



**Availability:** Rare (Soviet State Secret)  
**Constructed by:** Soviet Armed Forces  
**Invented by:** THE GREMLIN™  
**Worn by:** Unidentified Soviet Officer

F A S E R I P  
 Ex Ex Ex Ty Gd Gd Gd

**ABILITY MODIFIERS:** None

**KNOWN POWERS**

**FLIGHT**

- Powered by thrusters installed in the boots.
- Turning made by using the power gauntlets.
- May fly at Good (4 areas/round) speed for an unlimited time.

**POWER GAUNTLETS**

- Power receivers installed in each glove allows Devastator to pull power down from the sky.
- Range of 10 areas.
- Inflict up to Monstrous Slugfest damage with power bolts.

**SATELLITE LINK-UP**

- All of Devastator's power is beamed to him from a satellite network stationed in geosynch orbit around the globe.
- These satellites are protected by Remarkable ECMs rendering them invisible to normal detection.
- The transmitters within Devastator's gloves provide an unlimited supply of power, but also form an open conduit back to the network. The satellites may be damaged or destroyed by energy feeding back through the gloves.

**DESIGN NOTES**

The Devastator suit was the invention of the Gremlin, the deformed son of the equally hideous original GARGOYLE™. Both Gargoyle and his son were superior intellects in Soviet science. Gargoyle was cured of his radiation-induced deformity by Bruce Banner after the scientist and the Hulk battled. Gargoyle died soon after, and his son was informed by the state that Hulk was responsible. The Devastator battlesuit was constructed and the power satellite launched. The first wearer of the Devastator suit was destroyed when the Hulk contained his power blasts, turning them on the wearer. A second suit was built by the state, using the now-traitorous Gremlin's notes, but this suit was neutralized by the Gremlin and two armored allies from America. The satellite was destroyed in this encounter, but again, the plans remain a Soviet state secret, and another suit may be created.

**GUARDIAN ARMOR**

**Availability:** Unique  
**Constructed by:** Department H  
**Inventor:** James MacDonald Hudson  
**Worn by:** James MacDonald Hudson

F A S E R I P  
 Ex Gd Gd Ex In Gd Ex



**Recreated by:** Delphine Courtney  
**Modified by:** Roger Bochs and Madison Jeffries  
**Worn by:** Heather Hudson

F A S E R I P  
 Ty Gd Ty Ex Gd Ex Gd

**ABILITY MODIFIERS**

- Raises Agility by 3 ranks (Maximum of INCREDIBLE)
- Raises Strength by 3 ranks (Maximum of REMARKABLE)

**KNOWN POWERS**

**BODY ARMOR**

- Steel mesh battlesuit reinforced by personal force-field generator.
- Provides Amazing protection from physical attack.
- Provides Incredible protection from Energy Attacks, including heat and cold.
- The force field dampens, but does not eliminate, inertia from physical attacks. The wearer may still be stunned and slammed by attacks.
- The force field must be on to be used, otherwise the suit provides only Good body armor. The field is considered "on" when in flight or firing the suit's weaponry.

**FLIGHT**

- Flight is attained by directing dispersed beams of electromagnetic energy against the ground.

- May reach Incredible speed, 7 areas/round) in this fashion.

**ENERGY BEAM**

- By manipulating the electromagnetic stress patterns, the user may tire a bolt of concussive energy once per round.
- Range of the bolt is 10 areas.
- May inflict up to Incredible Slugfest damage.

**TRANSPORT**

- While in operation, appears as a "teleport." This special form of transportation is not a standard form of teleportation.
- The wearer may stop himself or herself with respect to the rotation of the earth, allowing sudden movement to the west at thousands of miles an hour, appearing as if instantly vanishing.
- On-board computers prevent the suit from smashing into mountain ranges and other tall obstructions.

**DIGGING ABILITY**

- The initial design of the Guardian armor was for use in exploration of oil. Despite its altered purpose, it still has some abilities in this area.
- The wearer may tunnel underground, moving at 3 areas per round, or 2 areas per round if forming a tunnel for others to follow.

**DESIGN NOTES**

The cybernetic helmet that is the key to controlling the energy-shaping technology of the Guardian suit was developed by James MacDonald Hudson while still in college. Upon graduation, he was employed by JERRY JAXON™ of AM-CAN PETRO-CHEMICAL™ in Canada, to use his discovery to develop an exploratory super-suit. Upon discovering that the suit was to be used by the US Military, Hudson destroyed the plans and took the helmet which controls the suit, which by rights was his.

Hudson, now unemployed and awaiting arrest for his actions, was rescued by HEATHER MCNEIL™, Jaxon's secretary. Heather had fallen for Hudson, and used her minor connections in government to put Hudson in touch with the Canadian Government. The Prime Minister was intrigued by Hudson's discoveries, and set up the young scientist in a secret "Department H" to work with super-powered individuals. His first was Logan, now known as WOLVERINE™.

With the initial space flight of the FANTASTIC FOUR™ and the development of their amazing powers, Hudson developed a purpose for his department—to create a hero for use by the Canadian Government. His first mission, as WEAPON ALPHA™, was to recover Wolverine, and ended in his defeat by the X-Men. The second meeting took place on Canadian soil, with Guardian backed up by Alpha Flight his own team of super-powered heroes. Wolverine escaped a second time, and eventually peace was made between the mutant and the Canadian government.

Hudson led Alpha Flight wearing the Guardian suit until his death at the hands of



Jerry Jaxon, linked to the Box armor (see BOX ARMOR.) Hudson apparently returned from the dead, but this was merely a plot by the robot Delphine Courtney. The robot was destroyed, but enough of the suit and cybernetic helmet survived to be modified by Madison Jeffries and Bochs into a second possible set with similar powers. The armor is being worn by Heather Hudson in her new role as VINDICATOR™.

**GUARDSMAN™ ARMOR**



**Availability:** Unique  
**Constructed by:** Stark Industries  
**Inventor:** Tony Stark  
**Worn by:** Michael O'Brien, Security Director

F A S E R I P  
 Gd Gd Ty Gd Gd Gd Gd

**ABILITY MODIFIERS**

Raises Fighting by 1 rank  
 (Maximum of EXCELLENT)  
 Raises Agility by 1 rank  
 (Maximum of EXCELLENT)  
 Raises Strength by 4 ranks  
 (Maximum of INCREDIBLE)  
 Raises Endurance by 4 ranks  
 (Maximum of AMAZING)

**KNOWN POWERS**

**BODY ARMOR**

- Steel mesh-covered exoskeleton
- Provides Incredible protection from physical damage.

- Provides Excellent protection from most energy attacks, including heat and cold.
- Provides Monstrous protection from radiation

**FLIGHT**

- Powered by chemically-fueled boot jets
- May fly at 6 areas per round
- If used as weapons, the boot jets inflict Excellent damage to those within the same area.

**REPULSORS**

- Medium-density plasma projectors similar to those found in the Iron Man Golden Avenger armor. Outlet is located in each palm.
- Range of 5 areas
- May inflict up to Incredible damage
- May be fired at separate targets.

**AIR SUPPLY**

- Internal air supply provided within the armor contains sufficient air of 1 hour.
- This air supply is used primarily in fLight.

**OVERRIDE**

- The Guardsman armor lacks the energy absorption or override abilities of the Iron Man armor.

**DESIGN NOTES**

The Guardsman armor was designed as a backup for the Iron Man armor by Tony Stark, and was given to co-worker and confidante KEVIN O'BRIEN™. Calling himself the Guardsman, O'Brien used the armor to save Iron Man, but faulty circuitry within the helmet affected his personality, turning him against the Golden Avenger. Kevin O'Brien died in an explosion while fighting Iron Man. Stark International retained the armor.

Kevin's brother, Michael O'Brien, broke into Stark Industries months later and stole the armor, intent on investigating his brother's death, but the mood-altering nature of the malfunction soon turned him against Iron Man as well. Iron Man managed to subdue Michael and corrected the faulty component in the armor. Michael dropped his vendetta against Iron Man and saved his life in a battle against the mutant SUNFIRE™. Iron Man gave O'Brien the armor in repayment. Michael O'Brien is currently head of security for PROJECT PEGASUS™.

**IRON MONGER ARMOR**

**Availability:** Unique, plans exist in Stane computers.

**Constructed by:** Shane International  
**Inventor:** A team of Stane scientists working from notes left by Tony Stark.

**Worn by:** Obadiah Stane

F A S E R I P  
 Ty Ty Ty Gd Gd Ex Gd

**ABILITY MODIFIERS**

Raises Fighting by 3 ranks  
 (Maximum of EXCELLENT)  
 Raises Agility by 1 rank  
 (Maximum of GOOD)



Raises Strength by 3 ranks  
 (Maximum of INCREDIBLE)  
 Raises Endurance by 6 ranks  
 (Maximum of MONSTROUS)

**KNOWN POWERS**

**BODY ARMOR**

- Built similarly to the Iron Man Golden Avenger armor, the Iron Monger armor replaced the molecular-plating with thick alloy steel and fully protected, articulated joints.
- Amazing protection from physical and energy damage and attacks.
- Unearthly resistance to radiation.
- Incredible resistance to heat, cold, and acid.
- Unearthly resistance to electricity.

**FLIGHT**

- The armor flies by means of gyro-stabilized turbines that allow the wearer to maintain a standing position while flying.
- Normal flight is at Amazing (8 areas/round) speed.
- Boot jets, if used as weapons, inflict Incredible damage against targets in same area

**REPULSORS**

- Medium-density plasma projectors of the Iron Man (Golden Avenger) design. Outlet set into each palm.
- Range of 10 areas.
- May inflict up to Monstrous damage.
- May be fired at separate targets (as Golden Avenger armor)

**LASER UNIBEAM**

- Another development of Stark International technology, the unibeam has shed all illuminating abilities and turned into a purely offensive weapon.
- Laser has 5-area range.
- Laser may inflict up to Amazing damage.

**AIR SUPPLY**

- Though not proven in combat, the Iron Monger armor may be assumed to have similar properties as the Iron Man Golden Avenger armor it was based upon.

**COMPUTER CONTROL**

- The Fighting, Agility, and combat shifts granted to the wearer of this suit apply only if the wearer is within range (10 miles) of the central computer. Fighting and Agility is normal (with maximum listed) if deprived of that contact.
- The computer control allows a neophyte to command the Iron Monger at peak ability, without requiring a Reason FEAT roll to operate the armor. If deprived of that contact, experienced in dealing with the armor must make a FEAT roll as a first time wearer.

**DESIGN NOTES**

Obadiah Stane was a ruthless businessman who gained control of Stark International by shifty business and illegal tactics, and by driving Tony Stark deeper into his alcoholism. Upon gaining control, a large number of Stark's employees resigned, and most of the Iron Man technology was destroyed as well by Jim Rhodes. Stane did discover a notebook containing Stark's writing, and on the basis of this, assigned his team of scientists to create his own battlesuit, known as the Iron Monger.

Though Stane was not involved directly in the testing, the computer hook-up running the suit allowed the businessman to use it against Stark when the hero arrived in his new armor to avenge Morley Erwin's death (See Silver Sphinx armor for details on new suit). After besting several of Stane's challenges, Stark discovered the hook-up and destroyed the computer link, removing Stane's advantage. No longer able to control the suit fully, Stane was easily defeated, but committed suicide rather than be taken in by Stark. With Stane's death, the armor is controlled by Stane/Stark International, but nothing is known of its present location.

**LIGHTMASTER™ SUIT**

**Availability:** Unique  
**Constructed by:** D, Edward Lansky  
**Inventor:** Dr. Edward Lansky  
**Worn by:** Dr. Edward Lansky

F A S E R I P  
 Ty Gd Ty Gd Ex Ex Ty

**ABILITY MODIFIERS:** NONE

**KNOWN POWERS**

**FLIGHT**

- Gravity-pump circuitry, which is the key to all suit powers, manipulating light.
- May fly up to 6 areas per turn, carrying only what the wearer may hold in his or her arms.

**LIGHT MANIPULATION**

- The suit grants the wearer Amazing control over light.



- A blinding flash of Amazing intensity may be generated.
- The suit may create discrete semi-solid objects of light. These objects are of Remarkable strength material.
- Such objects may be "fired" for Remarkable energy damage, S&T.
- By solidifying this light at the fists, Lightmaster may inflict up to Remarkable damage.

**ENERGY ABSORPTION**

- The circuitry of the suit may absorb an Unearthly amount of electrical or light energy without damage to the user.
- Should further energy be pumped into the suit, a short-circuit occurs. The wearer must make an Endurance FEAT roll or be transformed into living energy. As such, the wearer must maintain its energy level or perish.

**DESIGN NOTES**

The lightmaster suit was designed and built by Dr. Lansky, vice-chancellor of Empire State University, to be used in a criminal conspiracy against the government of New York City, which had cut his budget. Lansky fought and was defeated by Spider-Man, who overloaded the suit, converting Lansky to light and later sending him to a "light dimension." Returning to his normal form through the control of QUASAR™, Lightmaster was again defeated by Spider-Man. Lansky is currently in prison, but his original plans and other versions of the suit may survive.

**MANDROID™ ARMOR**

**Availability:** NA/2,000r  
**Constructed by:** Stark International  
**Inventor:** Stark International  
**Worn by:** Agents of SHIELD (sometimes)

F A S E R I P  
 Gd Gd Gd Gd Ty Ty Ty

**ABILITY MODIFIERS**

- Raises Agility by 1 rank (Maximum of GOOD)
- Raises Strength by 2 ranks (Maximum of EXCELLENT)
- Raises Strength by 1 rank (Maximum of EXCELLENT)

**KNOWN POWERS**

**BODY ARMOR**

- Constructed of titanium alloy
- Provides Incredible protection from physical attacks.
- Provides Incredible protection from energy attacks.

**AIR SUPPLY**

- Total internal life support system
- Can support normal functions for 24 hours.

**NEURO-STUNNER**

- More refined version of the Stun Cannon.
- Hits with Incredible potency stun ray.
- Range of 1 area.
- Inflicts no real damage other than stunning.

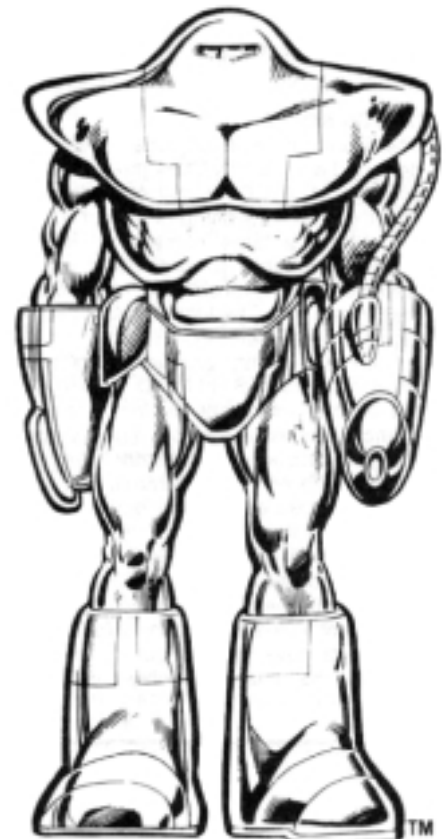

### PUNCH BLASTERS

- Also installed in the arms of the armor.
- Operates off magnetic force.
- Inflict up to Remarkable damage up to 1 area away.

### ELECTROSTATIC BEAMS

- High voltage electrical dischargers.
- Inflict Remarkable damage up to 2 areas away.

### LASER

- 250-watt laser/cutting torch.
- Inflicts Excellent damage.
- Range of 7 areas.

### TRACTOR-REPELLOR

- Field generator used to manipulate objects at distance.
- Perform as if Remarkable strength.
- May be used to escape grappling attacks.
- Maximum range of 3 areas.

### SENSORS

- Infravision for 3 areas.
- Radar/Sonar display of Remarkable ability.
- Full range radio and communication system, including loudspeaker.
- All senses of wearer receive Remarkable protection.

### REMOTE CONTROL

- Communication system is such that external sources may take over programming in event of wearer failure.
- Alternately, suits may be pre-programmed to follow certain actions should the wearer be incapacitated.

### OVERRIDE

- Mandroid suits have no override capabilities.

### DESIGN NOTES

The Mandroid is a personal combat suit designed and built by Stark International for use by S.H.I.E.L.D. in their operations. The thinking behind the Mandroid armor is to give the wearer a large number of offensive options available to provide a variable response to the level of threat. In some cases that threat may include those posed by super-powered heroes or villains.

Stark apparently produced this suit in great numbers for S.H.I.E.L.D. before getting out of the armament business, and the agency may now rely on other suppliers using the data provided by Stark. Many of the suits have been lost in combat and others have disappeared in raids on S.H.I.E.L.D. armories. Of these "rogue units," many have fallen into the hands of the underground, and have turned up as far away as Japan.

Despite (or perhaps because of) the great number of response options available, the mandroids have been singularly ineffective except in the hands of a highly skilled operator.

### MAN-ELEPHANT™ ARMOR



**Availability:** Unique

**Constructed by:** Haller Hydraulics, Inc.

**Inventor:** Manfred Ellsworth Haller

**Worn by:** Manfred Ellsworth Haller

F A S E R I P  
Ty Ty Ty Gd Ex Ty Ty

### ABILITY MODIFIERS

Raises Agility by 1 rank

(Maximum of EXCELLENT)

Raises Strength by 3 ranks

(Maximum of REMARKABLE)

Raises Endurance by 5 ranks

(Maximum of AMAZING)

### KNOWN POWERS

#### BODY ARMOR

- Reinforced texturized rubberized woven plastic "hide".
- Provides Incredible protection from physical attacks.
- Provides Excellent protection from energy attacks, including radiation, heat and cold.

#### HYDRAULIC LOCK

- Hydraulic armatures along the arms and legs may increase damage.
- In grappling, the wearer can increase strength to Incredible strength.

#### TUSKS

- Removable tool-steel tusks, carried on the helmet.
- Wearer may attack with tusks for Excellent H&S damage.
- May be removed from helmet, attached by chains to a winch within suit. In this fashion the tusks may be thrown up to 2 areas away, and used as grappling hooks.

### GAS

- The trunk contains Amazing potency knock-out gas.
- May be used only against an opponent being grappled by the wearer.

### SONIC ATTACK

- Also located in the trunk assembly.
- May issue a sonic "bellow" of Typical Intensity, incapacitating those who fail an Endurance FEAT roll.

### SENSOR DEVICES

- Full-band radios installed in suit's helmet.
- Sound-gathering devices placed in ears allow the wearer to detect normal conversations up to 4 areas away.

### DESIGN NOTES

The Man-Elephant armor was and is a blatantly silly set of armor. Manfred E. Haller built the suit using existing off-the-shelf technology available through his company, Haller Hydraulics. In a move designed to promote his company and products, Haller volunteered to bring in the SHE-HULK™, thought at the time to be a dangerous menace. Though his offer was turned down by the local sheriff, Haller went on local TV and challenged the She-Hulk to combat. Attacking She-Hulk, Haller was defeated, and later apologized publicly for his rash and potentially dangerous actions in picking a fight. He has stated that the suit and its components have come off the market, but it is unknown if someone else has the suit.

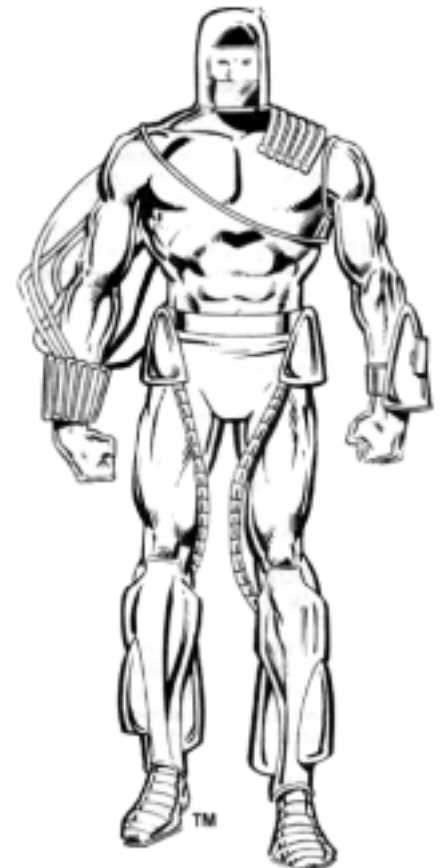

## MAULER™ ARMOR

**Availability:** Unique

**Constructed by:** Cord Conglomerate

**Inventor:** Edwin Cord and Associates

**Worn by:** BRENDAN DOYLE™, Mercenary

F A S E R I P  
Rm Gd Gd Ex Gd Ex Gd

### ABILITY MODIFIERS

Raises Fighting by 1 rank  
(Maximum of AMAZING)

Raises Agility by 1 rank  
(Maximum of EXCELLENT)

Raises Strength by 3 ranks  
(Maximum of INCREDIBLE)

Raises Endurance by 3 ranks  
(Maximum of INCREDIBLE)

### KNOWN POWERS

#### BODY ARMOR

- Molecular-scale woven metal fabric.
- Provides Remarkable protection from physical attacks.
- Provides Incredible protection from energy attacks, including heat and cold.

#### LASER CANNON

- Solid state 600 watt laser cannon mounted in the right arm assembly.
- Capable of inflicting up to Monstrous damage.
- Effective range of 15 areas.

#### ELECTRON PARTICLE BEAM

- 400 watt electron particle gun also mounted in right arm assembly, using loser cannon in short-pulse mode as a guide.
- Inflicts Amazing damage. Damage cannot be reduced.
- Effective range of 10 areas.

#### FLIGHT

- Electric, air-breathing turbines set into the calves.
- Armor can move up to Amazing (8 areas) speed.

#### ELECTRIC SHOCK

- High-frequency, extremely short range electric shocker implanted in the left palm.
- May inflict up to Amazing electric damage if touching an opponent. (Fighting FEAT in normal combat)

#### LIFE SUPPORT SYSTEMS

- Internal life support systems can maintain the wearer for 3 1/2 days in a hostile environment.
- While the life support systems may allow survival in deep space or underwater, certain suit systems would be affected (such as the air-breathing turbines that allow flight).

#### DESIGN NOTES

The MAULER armor (Mobile Armored Utility Laser-guided E-beam, Revised) was developed by the Cord Conglomerate under contract with the United States Government. The

suit was stolen by a disgruntled employee of Cord's named AARON SOAMES™, and later by TURK BARRETT™, a small-time thug with a grudge against Daredevil (see STILTMAN). Because of such breaches in security, the Department of Defense cut the funding for the project. Cordco collapsed after an affair with the Raider armor (see Raider Armor) and the company was purchased by Stark international.

Cord, now in prison, contacted mercenary Brendan Doyle to steal the suit and destroy any plans in the computer systems, allowing Cord to hire Doyle and the suit out as a super-powered mercenary. Doyle stole the suit from the Stark International warehouse on Long Island, but was foiled by Jim Rhodes, who broadcast the plans to a wide variety of Stark locations. Rather than slay Rhodes, who Doyle had served alongside in South East Asia, Doyle resigned his allegiance to Cord, and left with the suit. Present whereabouts of the suit are unknown. In addition, plans exist for the suit in numerous locations.



## PORCUPINE™ ARMOR

**Availability:** Unique

**Constructed by:** ALEX GENTRY

**Inventor:** Alex Gentry

**Worn by:** Alex Gentry

F A S E R I P  
Ex Gd Ex Rm Gd Gd Ty

**ABILITY MODIFIERS:** NONE

### KNOWN POWERS

#### BODY ARMOR

- The Porcupine armor is a high-alloy molecular chain mail built for versatility and attack. It is studded with a plethora of razor-sharp quills.
- Provides Incredible protection from physical attacks.
- Provides Remarkable protection from energy attacks, including heat and cold.
- Any creature attacking the wearer in physical combat (including Slugfest and Grappling) without adequate protection are automatically hit with Good Slugfest damage. Adequate protection means Good body armor, or attacking behind, Good strength material.

#### HELMET

- Weakest spot in the Porcupine armor, though it is equally well-protected by quills.
- Provides only Remarkable protection, but those attacking the helmet need a yellow FEAT roll to hit.
- Helmet provides a 6-hour supply of compressed air for the user.
- Helmet is equipped with nightvision lenses to allow Gentry to see up to 3 areas in the dark.

#### STEEL QUILLS

- Ringing the faceplate and jutting from the arms, legs, and wrists are innumerable steel quills.
- In Slugfest combat, wearer of Porcupine armor inflicts Excellent Hack & Slash damage.
- In charging combat, wearer of Porcupine armor inflicts Remarkable Hack & Slash damage.
- Wearer of Porcupine armor may not inflict less damage when attacking in this fashion.

#### CONCUSSION BOMBS

- Fired from launchers in the wrists, these concussion bombs are aerostable quills.
- Are fired with Remarkable Agility up to 3 areas away.
- Bombs explode for Incredible damage against a single target.
- Maximum rate of fire is 3 targets per round.
- May alternately be loaded with knock-out gas of Amazing potency.

#### ELECTRICAL ATTACK

- Generated by the suit's internal electrical system and channeled through the gloves.
- Fired with Excellent Agility.
- Range of 3 areas inflicts Incredible damage to a single target.
- Rate of fire is once per round.

#### FLIGHT

- Flight is accomplished by gyro-stabilized boot-jets.
- Maximum speed is 3 areas per round.

## DESIGN NOTES

Alex Gentry was a weapons designer for the US Army who designed a personal battlesuit to use in crime. The original suit was a bulky creation, bristling with weapon systems Gentry's design philosophy seemed to be the best defense is a good offense. In this suit, he fought and lost to a variety of heroes. The suit was finally destroyed by Iron Man when the villain was in the service of Justin Hammer, Gentry returned to his labs and produced this present set of armor, intent on selling it to others and profiting much in the same way Hammer did from him. Seeking to interest the SECRET EMPIRE™, Gentry took on Captain America and NOMAD™, and was defeated. Porcupine was later killed, but his armor and designs survive him.

## RED RONIN™ ARMOR



**Availability:** Unique, Destroyed

**Constructed by:** Stark International Detroit Branch

**Inventor:** Drs. Cowen, Takiguchi, & Hashioki

**Controlled by:** DR. EARL COWAN™

F A S E R I P  
Pr Pr Pr Ty Ex Ty Pr

## ABILITY MODIFIERS

The Red Ronin Armor does not modify abilities, but rather has set abilities of its own.

Fighting is MONSTROUS level  
Agility is MONSTROUS level  
Strength is UNEARTHLY level  
Endurance is UNEARTHLY level  
The Armor is 25 stories tall, and cannot enter most buildings without destroying them.

## KNOWN POWERS

### BODY ARMOR

- Multiple thicknesses of high-alloy steel reinforced by a high-energy proton field.
- Provides Uearthly protection from physical attack when proton field is engaged. Monstrous protection when it is not.
- Provides Uearthly protection against energy attacks, including heat cold, electricity, and radiation.

### FLIGHT

- Multiple chemical thrusters installed in the lower legs and feet.
- Allows Uearthly (10 areas/round) flight for limited distances (500 miles maximum)

### LASER DISK

- 20-foot diameter hand-held shield with light-blade 30 feet long. May reach into adjacent areas with blade.
- Light-blade inflicts Uearthly Slugfest damage to all it comes in contact with, and is not affected by the proton field of the armor (and as such may damage the armor).
- The armor deals with targets outside the range of its blade by throwing the disk at an opponent for Uearthly Slugfest damage. If Red Ronin makes a successful Agility FEAT roll, the disk returns to its hand.

### AIR FANS

- The helmet of the armor contains the control room for the suit and is protected by Amazing Strength vent fans, which should clear the area around the head of smoke or gas in a single round.

### HAND BLASTER

- Set into the left hand of the armor.
- Range of 20 areas.
- Inflicts no less than Excellent but not more than Uearthly damage.

### CYBERNETIC CONTROL

- The 12-story armor is controlled from a cybernetic linkage located in the head of the suit.
- At the time of its latest rampage the linkage was keyed to respond only to the thoughts of Dr. Cowan.
- The Red Ronin Armor has Amazing strength ECMs end cannot be overridden by external signals.

### INTERNAL SECURITY

- Given the large size of the armor, the many passageways and access hatches have electronic guardians.
- All external hatches, such as those in the feet are protected by Uearthly strength stun-beams which inflict no damage but stun with Uearthly intensity.

- All internal access ways may be monitored from the control room in the head.
- Discrete areas may be flooded with Remarkable strength knock-out gas.

## DESIGN NOTES

Originally invented by the Japanese experts Takiguchi and Hashioki, the Red Ronin armor was designed to hunt down and neutralize radiation-spawned monsters in the Pacific Basin. The Red Ronin sun was almost completely destroyed in battle with several of these monsters, but was rebuilt by Dr. Earl Cowan at the Detroit Branch of Stark International.

Cowan was possessed with an intense case of cold-war hysteria. He thought that the only way to remove the fears of a world war would be to initiate it. To that end, he took the Ronin armor and headed east hoping to reach the edge of the continent and fly to the Soviet Union. The huge robot crossed the paths of the AVENGERS™, who, aided by the S.H.I.E.L.D. anti-monster aircraft, the Behemoth, managed to defeat the suit. The suit was destroyed, and Cowan institutionalized.

The Red Ronin armor is not a battlesuit in the standard sense. Its total actions are controlled by a single person, and its function in fighting giant monsters and robots is included in this book.

## SECBOTS

**Availability:** NA/1,500r

**Constructed by:** Various defense contractors

**Inventor:** Unknown





**Worn by:** Security Force USAF Cheyenne Mountain

F A S E R I P  
Gd Gd Gd Gd Ty Ty Ty

**KNOWN POWERS**

**BODY ARMOR**

- Constructed of tungsten-reinforced steel.
- Provides Remarkable protection from physical attack.
- Provides Remarkable protection from energy attacks including heat and cold.
- Provides Monstrous resistance to radiation.

**RESTRAINING DEVICES**

- Catchweb throwers installed in one hand.
- Catchweb, if hits, ensnares the target in titanium steel cable of Incredible strength. The cables tighten as the target struggles forcing the character to make an Endurance FEAT roll or pass out.

**SENSORS**

- Full band scanners extending into the infrared and ultraviolet spectrums.
- Communication monitors capable of picking up signal within 3 miles.
- Exotic energy detectors that do not detect a mutant per se, but discover odd energy patterns within 500 yards.

**DESIGN NOTES**

The Secbots are a less-powerful version of the Mandroid armor which they resemble, but are designed for passive protection of government installations, as opposed to active missions in the field. The name is a shortening of Security Robot. Examples of these battlesuits may be found in high-security installations such as the North American Air Defense Command in Cheyenne Mountain (code Name—VALHALLA).

**S.H.I.E.L.D. UNIFORM**

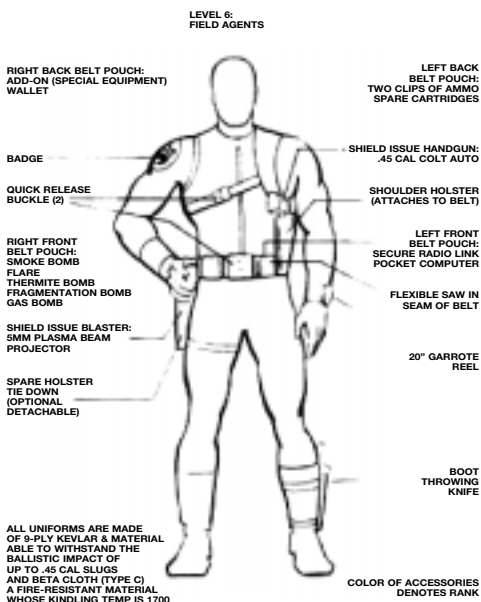

**Availability:** NA/100r  
**Constructed by:** S.H.I.E.L.D.  
**Inventor:** Sidney Levine and others  
**Worn by:** Agents of S.H.I.E.L.D.

F A S E R I P  
Gd Ty Ty Gd Ty Ty Ty

**ABILITY MODIFIERS: NONE**

**KNOWN POWERS**

**BODY ARMOR**

- 9-ply kevlar backed by Type C Beta Cloth.
- Provides Typical protection from physical attacks.
- Provides Excellent protection from energy attacks including heat and radiation, but not cold.

**DESIGN NOTES**

This is the standard issue S.H.I.E.L.D. uniform worn at S.H.I.E.L.D. headquarters and even field maneuvers. Color of the bands and piping denotes rank in the organization:

- Level 1: White  
Executive Director (NICK FURY™)
- Level 2: Pale Yellow  
Special Director (DUM-DUM DUGAN™)
- Level 3: Yellow  
Regional Director (ERIC KOENIG™)
- Level 4: Orange  
Special Officers (SHARON CARTER™)
- Level 5: Red-Orange  
Regional Officers (JERRY HUNT™)
- Level 6: Red  
Field Agents (GAIL RUNCITER™)
- Level 7: Brown  
Administrators (HAROLD JOHNSON™)
- Level 8: Gray  
Technicians (SIDNEY LEVINE™)



**SOVIET SUPER TROOPER™ ARMOR**

**Availability:** Rare  
**Constructed by:** USSR Contractors  
**Invented by:** The Gremlin  
**Worn by:** Officers under the command of the Bureau of Military Mysteries

F A S E R I P  
Ex Gd Gd Gd Ty Ty Ty

**ABILITY MODIFIERS**

- Raises Strength by 2 ranks (Maximum of REMARKABLE)
- Raises Endurance by 2 ranks (Maximum of REMARKABLE)

**KNOWN POWERS**

**BODY ARMOR**

- Constructed of reinforced steel alloy.

- Provides Remarkable protection from physical attack.
- Provides Good protection from energy attacks.

**FLIGHT**

- Powered by high-efficiency boot-jets.
- Flies at Typical (3 areas/round) speed for up to 8 hours.
- If used as weapons, the boot-jets may inflict up to Excellent damage to those within the same area.



**ENERGY BLAST**

- Power blasters similar in design to those in the Devastator armor, but lacking the satellite power source.
- May inflict up to Remarkable damage.
- Range of 3 areas.

**DESIGN NOTES**

The Soviet Super-Troopers were another design by the Gremlin used to battle the U.S. and the Incredible Hulk. Seeking a suit design that could be produced in relative mass quantities the Super-Troopers sought to make up in numbers what they lacked in individual power. The Hulk easily fought through the Soviet detachment of these troops and reduced Gremlin's arctic base of Bitterfrost to ruins.

When Gremlin turned against the state, this battlesuit was made available to several branches of the armed services including the Bureau of Military Mysteries which controls activity in the Forbidden Zone, a realm of runaway experiments A "wing" of super-trooper numbers 9 (three groups of three) and may be commanded by another trooper or by a super-powered Soviet citizen such as Devastator or Crimson Dynamo. The Soviet Super-Troopers remain a state secret.

## STILT-MAN™ ARMOR



**Availability:** Unique  
**Constructed by:** WILBUR DAY™/Cordco  
**Inventor:** Wilbur Day  
**Worn by:** Wilbur Day

F A S E R I P  
 Gd Gd Ty Ty Rm Gd Ty

### ABILITY MODIFIERS

Raises Agility by 2 ranks  
 (Maximum of EXCELLENT)  
 Raises Strength by 1 rank  
 (Maximum of EXCELLENT)  
 Raises Endurance by 3 ranks  
 (Maximum of REMARKABLE)

### KNOWN POWERS

#### BODY ARMOR

- Constructed of tool-steel alloy.
- Provides Incredible protection from physical attack.
- Provides Remarkable protection from energy attacks.
- The surface of the armor is coated with a non-stick coating of Monstrous potency, allowing the wearer to escape most ensnarements.

### STILTS

- Tool-steel alloy hydraulic rams with stainless steel sheeting.
- Allows movement of 4 areas per round.
- Maximum elongation of 290 feet, allowing the user to clear a 25-story building while walking normally.
- Used as weapons, the rams may be wielded for Incredible damage in a 1-area range.

### AIR SUPPLY

- Self-contained air and gas mask allows 2 hours self-contained air.

### STUN GAS NOZZLES

- Installed in right arm, nozzles in first two fingers. Storage for gas in lower right arm.
- Incredible intensity stun gas knocks opponents out for 1-10 rounds.
- Range of 2 rounds, but the user may enshroud himself in gas as he grows, allowing a full 25-story cloud surrounding the user.

### DESIGN NOTES

Wilbur Day stole a new design of hydraulic ram designed by KARL KAXTON™ of Kaxton Industries and used it as the basis for his first suit of Stilt-Man armor. Using this suit, Day had an early success against Spider-Man, but was eventually defeated by Daredevil. Day continued to refine his suit, and at one point built a suit of adamantium alloy with the aid of the extra-dimensional barbarian BLASTAAR™. This suit raised Strength and Endurance to Monstrous levels as well as potential damage and provided Unearthly body armor. This armor was later destroyed.

Returning to his original suit Day was overpowered by Turk Barrett who stole the armor to make a kidnapping attempt for KINGPIN™. This theft so infuriated Day that he informed Daredevil how to override the suit, allowing the Man without Fear to easily beat Turk. With the original suit in police custody, Day broke into an empty Cordco automated factory to build a new suit Spider-Man attempted to stop him, but was defeated by Still-Man in his new armor. It may be presumed that Day has changed or removed the method for shutting down the armor with its redesign.

## STINGRAY™ ARMOR

**Availability:** Unique  
**Constructed by:** DR WALTER NEWELL™  
**Inventor:** Dr Walter Newell  
**Worn by:** Dr Walter Newell

F A S E R I P  
 Gd Gd Ty Gd Ex Gd Gd

### ABILITY MODIFIERS

Raises Agility by 3 ranks  
 (Maximum of REMARKABLE)  
 Raises Strength by 5 ranks  
 (Maximum of AMAZING)  
 Raises Endurance by 3 ranks  
 (Maximum of INCREDIBLE)

## KNOWN POWERS

### BODY ARMOR

- Reinforced plastic-based artificial cartilage.
- Provides Remarkable protection from physical attacks.
- Provides Excellent protection from energy attacks.
- Provides Amazing protection from attacks of heat and cold.
- Provides Amazing protection from electrical attacks.

### WATER BREATHING

- Oxygen-diffusing system designed by Dr. Newell built into suit.
- Allows unlimited breathing ability underwater.

### MOVEMENT

- Mini-turbine impellers placed beneath a wing membrane designed along the lines of a manta ray.
- May move 4 areas per round underwater.
- May glide up to 4 areas per round above water, and is capable of launching from the water level up to 10 stories up.

### BLASTERS

- Electrical discharge device placed within gauntlets, powered by a small thermo-electric generator.
- Range of 1 area above water, same area in water.
- Fires a bolt of electricity that may inflict up to Incredible damage and forces an Endurance FEAT roll or the target is unconscious for 1-10 rounds.



## DESIGN NOTES

Designed by oceanographer, Walter Newell under pressure from the U.S. Government, the Stingray suit was first used to defeat and detain a weakened SUB-MARINER™, who was under suspicion of aiding aliens in stealing the earth's oceans. Newell retained his suit afterward to aid him in his own studies of deep-sea life, (its maximum diving depth is 1,200 feet. Stingray has fought alongside Sub-Mariner, the THING™, and TRITON™ of the INHUMANS™. Dr. Newell has taken up residence on Hydrobase, an artificial floating island that is now used by the Avengers and Fantastic Four as a staging area for their aircraft.

## SUNTURION™



**Availability:** Unique

**Constructed by:** Roxxon/Brand Corporation

**Inventor:** Unknown

**Worn by:** No owner presently Previous owners include ARTHUR DEARBORN™ of Roxxon, and MIKE STONE™, formerly of CONTINENTAL TRUCKING™

## ABILITY MODIFIERS

Raises Agility to REMARKABLE  
Raises Strength to AMAZING  
Raises Endurance to UNEARTHLY

## KNOWN POWERS

### BODY ARMOR

- The Sunturiion is constructed of high quality plastics and metal, reinforced by ambient microwave radiation.
- Provides Incredible protection from physical attack.
- Provides Unearthly protection from all energy attacks, including heat, cold, and electricity.

### MICROWAVE BLASTS

- Energy of the user channeled through the gloves of the suit.
- May inflict up to Amazing energy damage.

## TELEPORT

- The suit provides Unearthly teleportation abilities at the speed of light, allowing almost instantaneous travel from point to point in the world.
- The wearer may not take other beings or items when teleporting.

## IMAGE GENERATION

- Circuitry within the suit allows the user to appear as a normal human while wearing the suit.
- This illusion is confined to that of the original user, and is a visual illusion only.

## DRAINING EFFECT

- Wearing the Sunturiion suit places the wearer in great danger. For every day the suit is worn, the user's real Endurance (as opposed to that the suit grants) is permanently reduced by one rank. When the user's Endurance reaches Shift 0, the user has been fully converted to energy and may not remove the suit afterward.
- If the suit is opened, torn, or cut after Shift 0 Endurance is reached, the energy stored within is released and the character within will die.
- A process may exist to stabilize the wearer's cell structure, converting it to microwave energy before placing it into the suit, allowing the wearer to survive such a loss. This is only a possibility.

## DESIGN NOTES

The Sunturiion suit was developed by Roxxon Oil in conjunction with their genetic research division, The Brand Corporation, under the auspices of Arthur Dearborn, who also volunteered as a test subject. The original purpose of the Sunturiion was to serve as guardian and crew for Star Well I, a Roxxon orbiting solar satellite that would beam power through microwaves to earth (the transmitters controlled by Roxxon, of course). The scientists at Brand, according to Dearborn, converted his mass to microwave energy, and though he thought he was Sunturiion, they apparently placed this mutated energy in the suit.

An accident on Star Well I resulted in the death of the entire town of Allentown, Iowa, and brought Iron Man in his Space Armor to investigate. Iron Man and Sunturiion battled, and knocked Star Well I out of orbit onto a course that would smash into Sarasota, Florida. Dearborn apparently sacrificed himself to power the Space Armor and let Iron Man detect the crashing space station. Iron Man believed Dearborn and Sunturiion dead after this.

Mike Stone, a trucker for the Continental Trucking Company who was tired for trafficking in drugs, found the suit while on a fishing trip in Florida. He donned the suit to get back at his former employer, but lacking Dearborn's mutagenic modifications, was soon absorbed by the suit. The hero Daredevil opened the suit, letting Stone's energy dissipate into the atmosphere, and defeated the second Sunturiion. The present state or location of the suit is unknown.

## TITANIUM MAN™ ARMOR



**Availability:** Unique, believed destroyed

**Constructed by:** Workers in a Soviet gulag

**Invented by:** Workers in a Soviet gulag

**Worn by:** BORIS BULLSKI™

F A S E R I P  
Gd Ex Gd Rm Gd Ex Gd

## ABILITY MODIFIERS

Raises Fighting by 2 ranks  
(Maximum of INCREDIBLE)  
Raises Agility by 1 rank  
(Maximum of REMARKABLE)  
Raises Strength by 4 ranks  
(Maximum of AMAZING)  
Raises Endurance by 6 ranks  
(Maximum of MONSTROUS)

## KNOWN POWERS

### BODY ARMOR

- The Titanium Man armor is a fully articulated suit of armor made of titanium and titanium-steel alloys.
- Provides Incredible protection against physical attack.
- Provides Monstrous protection from energy attacks, including heat, cold, and radiation.

### FLIGHT

- Miniature all-titanium jet engines mounted in the armor's boots, fueled by high octane fuel.
- Flies up to Incredible speed (7 areas/round) twice that in open country.

### BLASTERS

- Electron beam blaster set into the gauntlets.

- These blasters inflict up to Amazing damage at a range of 10 areas.

#### HEAT BEAM

- Laser heat beam shot from the eyes of the armor. Range of 5 areas.
- This beam inflicts up to Incredible heat damage to an opponent.

#### TRACTOR BEAM

- Anti-graviton attracting beam installed in gauntlets.
- Allow the wearer to lift up to 1 ton (Remarkable strength) at a distance of 5 areas.

#### “RADAR RINGS”

- Hoop-shaped coils of memory spring (coiled metal which return to a predetermined shape)
- Fired from gauntlets.
- If coil hits a target, it is considered to have entwined the opponent in a grappling attack.
- Coils are made of Remarkable strength material.
- Because of the lightweight nature of the memory spring coils, the radar rings are usually used against flying targets.

#### SCREENING CLOAK

- A recent modification to the armor installed by the scientist known as Sergei.
- Creates the illusion of another figure over the Titanium Man armor, in this case the golden-plated leader of the Green Liberation Front known as the Commander.
- This illusion is of Amazing intensity.

#### OVERRIDES

- Because of the poor choice of available materials, overriding capability is not as effective as in American battle-suits (comparable with Iron Man Golden Avenger armor).
- Strength or damage inflicted by any attack form except “radar rings” may be increased by one rank by overriding.
- Overriding is very dangerous. The wearer of the suit must make a red FEAT roll on the Shift 0 column each round of override.
- Failure to make this FEAT roll results in an explosion inflicting Amazing damage on all within same area, including the unprotected wearer. The armor may be considered worthless until repaired.

#### DESIGN NOTES

The Titanium Man armor was developed and designed by the same team of scientists and assistants that aided Anton Vanko in the building of the Crimson Dynamo armor. Following the initial failure of that armor, the scientists involved were sent to a gulag in Siberia run by Boris Bullski, a Communist Party official who had fallen out of favor with his superiors. Realizing his opportunity, Bullski impressed the scientists into working on a battle-suit for himself, with which he could defeat Iron

The prisoners performed an admirable job given the materials available, though the suit never reached its full design potential. Bullski

was defeated by Iron Man on numerous occasions, and fell from favor with his government. Finally regaining some trust from his superiors, Titanium Man masqueraded as the Commander leader of the GLF (See CREDIT CARD SOLDIER ARMOR) in a plot to destroy the US economic system. This plot was foiled by Beta Ray Bill and Sif. Bullski, making his escape through credit-card technology was apparently destroyed by a disaffected captive scientist. Whether Bullski was slain, or his armor or duplicates survive is uncertain.

#### TORPEDO™ ARMOR



**Availability:** Unique, presumed destroyed  
**Constructed by:** Michael Stivak  
**Inventor:** Michael Stivak  
**Worn by:** BROCK JONES™

F A S E R I P  
 Gd Ex Gd Ex Gd Ty Ty

**ABILITY MODIFIERS:** NONE

#### KNOWN POWERS

##### BODY ARMOR

- Built of a combination human and alien technology of unstated material.
- Provides Remarkable protection from physical attack.
- Provides Unearthly protection from all forms of energy attack.

##### FLIGHT

- Nuclear-powered jet turbos located at the wrists and ankles.

- Fly up to 10 areas per round, 30 in open country.

#### POWER PUNCHES

- By using the Turbos in the wrists, the user may increase the damage done.
- Up to Incredible damage may be inflicted using these power punches.

#### VISOR

- Originally used to protect the eyes from wind while in high-speed flight.
- Have been modified to serve as an energy analyzer.
- As such, may note the presence of alien and exotic energies. In this fashion, mutants and shape-shifting aliens may be revealed in their true form.

#### DESIGN NOTES

The Torpedo armor was invented by Michael Stivak, nephew to US Senator Eugene Stivak. Senator Stivak had informed his nephew the purpose of the suit was for use by the defense department. In reality, Senator Stivak hoped to use the suit to his own ends, and the senator was in turn being used by a race of evil shape-changing aliens known as DIRE WRAITHS™. The younger Stivak discovered his uncle’s duplicity (though not the alien connection), and set out to destroy the original plans.

In the process of his mission, Stivak ran afoul of Daredevil who thought the Torpedo a villain. In the course of the battle, a wall fell on Michael Stivak. He died of injuries suffered, but not before explaining his fate to Brock Jones and asking the former pro football player to take the suit and destroy the plans. This Jones did, fighting Senator Stivak’s agents on numerous occasions. Discovering the alien connection, Jones fled with his family to Clairton, West Virginia.

In Clairton, Torpedo discovered more Dire Wraiths, and with the aid of a good alien cyborg, battled them as a protector of the small town. To aid him in protecting the town, Torpedo’s visors were modified to detect exotic radiation allowing him to see the Dire Wraiths in all their disguises. A sorcerous breed of the alien menace bewitched Jones’ mind, preventing him from registering the obvious wraiths around him. The wraiths rose en masse and destroyed the town, including Brock Jones. His Torpedo armor is believed lost in the burning of his house.

# WEAPONS

## COMMON WEAPONS

### CHEAP HANDGUN

**Price:** 2r/4r

**Range:** 2 areas

**Normal Damage:** 6 points, S&T

**Rate of Fire:** 1

**Number of Shots:** 6

**Design Notes:**

- May be fired with one hand.
- Poor strength materials (plastics).
- All-plastic guns may elude metal detectors. These are double price.
- Will not take specialized ammo
- Uses: Cheap weapon for small-time criminals, security item for home-owners.

### HANDGUN/PISTOL

**Price:** 5r/7r

**Range:** 3 areas

**Normal Damage:** 6 points, S&T

**Rate of Fire:** 1 shot/round

**Number of Shots:** 6, 8, or 9

**Design Notes:**

- May be fired with one hand.
- Excellent strength materials.
- May be modified to take specialized ammo at twice listed cost.
- Uses: Standard weapon for police forces, security guards, some criminals.

### TARGET PISTOL

**Price:** 7r/10r

**Range:** 5 areas

**Normal Damage:** 6 points, S&T

**Rate of Fire:** 1 shot/round

**Number of Shots:** 1

**Design Notes:**

- Raise Agility by one rank when fired with two hands.
- May be fired with one hand; sacrifices agility bonus.
- May be modified (twice cost) to take specialized ammo.
- Excellent strength materials
- Uses: Professional target shooters, hit

men. A finely balanced, very accurate gun.

### VARIABLE PISTOL

**Price:** 12r/20r

**Range:** 3 Areas

**Normal Damage:** 6 points, S&T

**Rate of Fire:** 1 shot/round

**Number of Shots:** 6, 8, or 9

**Design Notes:**

- As handgun/pistol with following changes:
- May be set in the field to a particular ammunition type without ill affect.
- Uses: Professionals who need a great deal of options, e.g. Bounty hunters.

### GYRO-JET PISTOL

**Price:** NA/15r

**Range:** 5 Areas

**Normal Damage:** 10 points, S&T

**Rate of Fire:** 1 shot every 2 rounds

**Number of Shots:** 3

**Design Notes:**

- May be fired with one hand.
- May carry Gyrojet ammunition.
- Use Illegal in most cities

### LASER PISTOL

**Price:** NA/30r

**Range:** 10 Areas

**Normal Damage:** 10 points, S&T

**Rate of Fire:** 1 shot/round

**Number of Shots:** 10 shots/power pack

**Design Notes:**

- May be fired one-handed.
- Requires no ammunition, only power pack.
- Use is illegal in most cities, is used by legal and para-legal authorities.
- Because of delicate nature of weapon, is rated at Poor strength material.

### STUN PISTOL

**Price:** NA/30r

**Range:** 2 Areas

**Normal Damage:** None; those hit must make an Endurance FEAT roll against Typical intensity stunning.

**Rate of Fire:** 1 shot/round

**Number of Shots:** 10 shots/power pack

**Design Notes:**

- Requires one hand to fire.
- Requires no ammo, operates off power pack.
- Use is Illegal in most cities Is used by legal and para-legal authorities.
- Poor strength materials.
- Also called Stunners, Stunlators, and Janglers. More powerful versions may exist.

### CONCUSSION PISTOLS

**Price:** NA/30r

**Range:** 4 Areas

**Normal Damage:** 10 points Slugfest

**Rate of Fire:** 1 shot/round

**Number of Shots:** 5 shots/power pack

**Design Notes:**

- Damage rolled on Slugfest column.
- Requires no ammo, operates off power pack.
- Requires one hand to fire.
- Used by organizations such as S.H.I.E.L.D. and A.I.M.
- Also called Blasters or Force Guns

### NEEDLE GUN (Nick Fury)

**Price:** NA/40r

**Range:** 6 Areas

**Normal Damage:** 20 points S&T

**Rate of Fire:** 1 shot/round

**Number of Shots:** 300

**Design Notes:**

- Example is property of Nick Fury.
- Fires a thin stream of razor-sharp needles.
- Excellent strength material.
- Mother of pearl hand grips.

### PLASMA BEAM HANDGUN (S.H.I.E.L.D.)

**Price:** NA/50r

**Range:** 7 Areas

**Normal Damage:** 20 points energy/Slugfest

**Rate of Fire:** 1 shot/round

**Number of Shots:** 10 shots/power pack

**Design Notes:**

- S.H.I.E.L.D. regulation issue.
- Excellent strength material
- May be fired with one hand





### MACHINE PISTOL (S.H.I.E.L.D.)

**Price:** 20r/35r

**Range:** 3 areas

**Normal Damage:** 20 points

**Rate of Fire:** 1 burst

**Number of Shots:** 6 bursts/clip

**Design Notes:**

- S.H.I.E.L.D. regulation issue.
- Excellent strength material.
- May be fired with one hand



### RIFLE

**Price:** 6r/10r

**Range:** 10 areas

**Normal Damage:** 10 points, S&T

**Rate of Fire:** 1/round

**Number of Shots:** 4

**Design Notes:**

- Requires two hands to fire.
- Good strength material.

### HUNTING RIFLE

**Price:** 8r/12r

**Range:** 10 areas

**Normal Damage:** 10 points S&T

**Rate of Fire:** 1/round

**Number of Shots:** 6, 7, or 8

**Design Notes:**

- Requires two hands to fire.
- Good strength materials.
- Common in rural areas

### SNIPER RIFLE

**Price:** 10r/20r

**Range:** 10 areas

**Normal Damage:** 15 points S&T

**Rate of Fire:** 1/round

**Number of Shots:** 4

**Design Notes:**

- Internal target site raise Ability by one rank to hit (Maximum of Remarkable).
- Must be fired with two hands.
- Good strength material.
- Uses: Military and criminal. Ownership not legal in most cities.

### ASSAULT RIFLE

**Price:** 15r/25r

**Range:** 7 areas

**Normal Damage:** 10 points/round

**Rate of Fire:** 2 shots/round

**Number of Shots:** 20 per clip

**Design Notes:**

- Range reduced by increased rate of fire.
- Must be fired with two hands.
- Good strength material.
- Uses: Military and criminal Private ownership not legal in most cities.

### LASER RIFLE

**Price:** NA/50r

**Range:** 4 areas

**Normal Damage:** 20 points, S&T

**Rate of Fire:** 1 shots/round

**Number of Shots:** 20/power pack

**Design Notes:**

- Requires two hands to fire.
- Typical strength materials.
- Uses: Military organized subversive criminals. Private ownership not legal.

### STUN RIFLE

**Price:** NA/50r

**Range:** 5 areas

**Normal Damage:** None, but target must make an Endurance FEAT roll against Remarkable intensity stun-ray.

**Rate of Fire:** 1 shots/round

**Number of Shots:** 20/power pack

**Design Notes:**

- Requires two hands to fire.
- Typical strength material.
- Uses: Specialized military force, organized criminal elements.

### CONCUSSION RIFLE

**Price:** NA/50r

**Range:** 7 Areas

**Normal Damage:** 10 pts Slugfest damage

**Rate of Fire:** 1 shots/round

**Number of Shots:** 12/power pack

**Design Notes:**

- Requires two hands to fire.
- Good strength material.
- Uses: Specialized military forces, subversive agencies.

### AUTOMATIC RIFLE

**Price:** 20r/30r

**Range:** 5 areas

**Normal damage:** 15 points S&T

**Rate of Fire:** 1 burst/round

**Number of Shots:** 20 bursts/clip

**Design Notes:**

- Requires two hands to fire.
- Good strength material.
- Uses: Military forces.
- A burst may hit up to three adjacent targets on a yellow FEAT roll.

### SHOTGUN

**Price:** 10r/20r

**Range:** 3 areas

**Normal Damage:** 20 points, S&T

**Rate of Fire:** 1 or 2 per round

**Number of Rounds:** 2

**Design Notes:**

- Requires two hands to fire.
- Good strength material.
- May use specialized ammo without modification.
- May hit up to three adjacent targets in the same area
- Uses: Common rural gun, criminals

### RIOT GUN

**Price:** 15r/20r

**Range:** 2 areas

**Normal Damage:** 15 points

**Rate of Fire:** 1/round

**Number of Shots:** 6

**Design Notes:**

- Excellent strength material.
- May be fired with one or two hands.
- Usually uses gas or specialized ammo.
- Uses: Law enforcement, crowd control.

### GRENADE LAUNCHER

**Price:** NA/30r

**Range:** 3 areas

**Normal Damage:** As for grenades

**Rate of Fire:** 1 every 2 rounds

**Number of Shots:** 1

**Design Notes:**

- Requires two hands to fire.
- Fires any of the listed grenades in Grenade section.
- Good strength material.
- Uses: Law, military some criminal.



### SUB-MACHINE GUN

**Price:** NA/40r

**Range:** 7 Areas

**Normal Damage:** 25 points, S&T

**Rate of Fire:** 1 burst/round

**Number of Shots:** 7 bursts/clip

#### Design Notes:

- Requires one or two hands to fire.
- Two-handed version is equipped with a shoulder stock.
- Good strength material.
- Burst may hit up to three adjacent targets for full damage to each (roll separately for each target)
- Uses: Military, terrorists. Possession illegal in most states.
- May not use specialized ammo.

### MACHINE GUNS

**Price:** NA/50r

**Range:** 10 Areas

**Normal Damage:** 30 points, S&T

**Rate of Fire:** 1 burst/round

**Number of Shots:** 20 bursts/clip

#### Design Notes:

- Must be stationary to fire.
- If mounted on vehicle, shift left two to hit.
- Bursts from a machine gun hit all targets in a single area, roll for each target.
- May not use specialized ammo
- Good strength material.
- Uses: Military, terrorists

### GATLING LASER (AIM)

**Price:** NA/100r

**Range:** 10 Areas

**Normal Damage:** 20 points, S&T

**Rate of Fire:** 1 burst/round

**Number of Shots:** 20 bursts/pack

#### Design Notes:

- Requires two hands to fire.
- Inflicts Excellent energy damage, S&T.
- Bursts hit all in target area.
- Uses no ammo, operates on power pack.
- Typical strength material.
- Uses: Para-military organizations.



### FLAMETHROWER

**Price:** NA/50r

**Range:** 2 areas

**Normal Damage:** 30 points S&T

**Rate of Fire:** 1/round

**Number of Shots:** 5 rounds

#### Design Notes:

- Requires two hands to fire.
- Fuel stored in backpack.
- Delivers fire damage, continues to burn for 10 points/round until put out.
- Hits all in target area.
- Weapon is Typical strength material, backpack is Good strength material.
- Damaging backpack may result in Amazing explosion to all in same area.
- Uses: Military operations

### BAZOOKA

**Price:** NA/70r

**Range:** 4 areas

**Normal Damage:** 40 points

**Rate of Fire:** 1 every 2 rounds

**Number of Shots:** 1

#### Design Notes:

- Requires two men to operate
- Good strength material.
- Above is damage for single target. Explosive shells available inflicting stated damage for all in that area.

### LIGHT ANTI-TANK WEAPON (LAW)

**Price:** NA/80r

**Range:** 4 areas

**Normal Damage:** 40 points

**Rate of Fire:** 1/round

**Number of Shots:** 6

#### Design Notes:

- Requires two hands to operate.
- Good strength material.
- Damage is for single type.
- Uses: Military

### LIGHT ARTILLERY

**Price:** NA/120r

**Range:** 10 areas

**Normal Damage:** 40 points

**Rate of Fire:** 1/round

**Number of Shots:** 20

#### Design Notes:

- Stationary to fire or suffer left three shift to hit.
- Excellent strength material.
- Damage is to all in area.
- May fire special ammunition.
- Uses: Military
- Requires two men to operate.
- Includes howitzers, mortars, and anti-aircraft guns.



### STUN CANNON

**Price:** NA/100r

**Range:** 10 areas

**Normal Damage:** None, fires a stunning beam of Incredible intensity.

**Rate of Fire:** 1/round

**Number of Shots:** 10/power pack

**Design Notes:**

- Upgrading of the stun rifle to its full extension.
- Remarkable strength material.
- Requires two men to fire. One man may fire it at a penalty of one shift.
- May be fitted onto a tank or other mobile launcher.

### CONCUSSION CANNON

**Price:** NA/100r

**Range:** 15 areas

**Normal Damage:** Incredible Slugfest damage

**Rate of Fire:** 1/round

**Number of Shots:** 10/power pack

**Design Notes:**

- Upgrading of the concussion rifle to its ultimate level.
- Remarkable strength material.
- Requires one man to fire.
- Also called force cannons or blast cannons.
- Uses: Military, special forces.

### LASER CANNON

**Price:** NA/150r

**Range:** 20 areas

**Normal Damage:** Remarkable energy, S&T

**Rate of Fire:** 1/round

**Number of Shots:** 10/power pack

**Design Notes:**

- Upgrading of laser rifle.
- Excellent strength material.
- Requires one man to fire.
- Uses: Military, special forces

### HEAVY ARTILLERY

**Price:** NA/200r

**Range:** 20 areas

**Normal Damage:** 50 points

**Rate of Fire:** 1/round

**Number of Shots:** 30

**Design Notes:**

- Requires two men to fire.
- Remarkable strength material.
- Single shell affects all in target area.
- Includes most guns from tanks and larger.

### SUPER HEAVY ARTILLERY

**Price:** NA/400r

**Range:** 25 areas

**Normal Damage:** 50 points S & T

**Rate of Fire:** 1 shot/round

**Number of Shots:** 30

**Design Notes:**

- Stationary but may swivel in place.
- Incredible strength material.
- Single shell affects all in target area.
- Includes battleship guns.
- Uses: Military.

### MISSILE LAUNCHER

**Price:** NA/300r

**Range:** Varies by missile

**Normal Damage:** 40 points

**Rate of Fire:** 1 to 10 missiles/round

**Number of Shots:** 10

**Design Notes:**

- Must be stationary while firing.
- Fires missiles (see entry under Missiles).
- Requires two people to fire.
- Uses: Military.

### FISSION BAZOOKA

**Price:** NA/300r

**Range:** 20 areas

**Normal Damage:** 40 points

**Rate of Fire:** 1/round

**Number of Shots:** 10

**Design Notes:**

- Will affect all within target area.
- Typical strength materials.
- If damaged, will explode in 1-10 rounds. The explosion inflicts Unearthly damage times the number of remaining shots (10 area radius). Amazing radiation damage is inflicted on any within that area for the next year.
- Uses: Security outposts far away from civilization.
- This example courtesy of Consolidated Conglomerates, Incorporated.

## SHIELD GUNS



**NICK FURY'S PERSONAL HANDGUN**  
 .15 CALIBER NEEDLE GUN.  
 NEEDLES HAVE A COLLAR OF EXPLOSIVE MATERIAL WHICH PROPEL THE NEEDLE AT OVER 1,800 FEET PER SECOND. CLIP HOLDS 300 ROUNDS MOTHER OF PEARL HANDGRIPS.



**S.H.I.E.L.D. REGULATION ISSUE:**  
 PLASMA BEAM HANDGUN.  
 PINCH BOTTLE MAGNETIC FIELD AND FOCUSING RING EMIT 3 KILOWATT 1-INCH COLLIMATED BEAM.  
 EFFECTIVE RANGE: 125 FEET  
 DURATION OF FIRE: 95 SECONDS  
 ON ONE POWER PACK.



**S.H.I.E.L.D. REGULATION ISSUE:**  
 .30 CALIBER RAPID FIRE AUTOMATIC MACHINE PISTOL.  
 ARMOR-PIERCING .30 CALIBER SHELLS HAVE SPENT URANIUM (HIGH DENSITY) CORES.  
 EACH CLIP HOLDS 60 ROUNDS ON A DISINTEGRATING LINK BELT.  
 HIGH CYCLIC RATE (VARIABLE RATE OF FIRE: FROM SINGLE SHOT TO 10 ROUNDS PER SECOND) ACHIEVED BY ONE PIECE FLOATING BOLT/RECEIVER.



## AMMUNITION

Ammunition is almost always purchased separately from weapons.

### STANDARD AMMUNITION

Standard ammunition inflicts the normal damage listed for that weapon.

Pistol (cheap, pistol, target, variable)

1r buys 50 rounds

Rifle (standard, hunting, and sniper)

1r buys 50 rounds

Assault Rifle

1r buys 30 rounds

Automatic Rifle

1r buys 1 clip

Sub-Machine Gun

2r buys 1 clip

Machine Gun

3r buys 1 clip

Shotgun

1r buys 10 rounds

Bazooka

1r buys 1 round

Fission Bazooka

20r buys 1 round

LAW

1r buys 1 round

Light Artillery

3r buys 1 round

Heavy Artillery

5r buys 1 round

Super-Heavy Artillery

10r buys 1 round

### POWER PACKS

For game purposes, the amount of charge for all power packs-using weapons of the same type (pistols, for example) are the same. Power packs may be manipulated to fit other weapon systems than they were designed for by making a Reason FEAT roll, and halve the number of available shots for each level of increase. (A pistol power pack modified to fit a rifle has 5 shots of pistol-type damage.)

Pistols (laser, stun, concussion)

5r for 1 power pack

Rifles (laser, stun, concussion)

10r for 1 power pack

Gatling Laser

20r for 1 power pack

Cannons (laser, stun, concussion)

30r for 1 power pack

### MERCY BULLETS

Mercy bullets inflict no damage, but affects the target with Remarkable potency knock-out drugs.

Handgun (pistol, target, variable)

1r buys 10 rounds

Rifle (standard, sniper)

1r buys 10 rounds

Assault Rifle

1r buys 5 rounds

Automatic Rifle

2r buys 1 clip

### ARMOR PIERCING BULLETS

Armor piercing bullets may ignore armor up to Excellent strength. Armor of that level or lower is treated as no armor.

Handgun (pistol, target, variable)

1r buys 10 rounds

Rifle (sniper)

1r buys 10 rounds

LAW

1r buys 1 round

### RUBBER BULLETS

Rubber bullets inflict Slugfest instead of shooting and throwing damage.

Handgun (pistol, target, variable)

1r buys 40 rounds

Rifle (standard, sniper)

1r buys 40 rounds

Assault Rifle

1r buys 40 rounds

### EXPLOSIVE BULLETS

Explosive bullets inflict twice normal damage.

Pistol (variable)

1r buys 10 rounds

Rifle (standard sniper)

1r buys 10 rounds

Bazooka

5r buys 1 round

### CANISTER SHOT

There are several types of canister shot, carrying different payloads. A weapon type that may take one type of canister may take other canisters made for that weapon type. All canisters have the same cost.

Bazooka

10r buys 1 round

Light Artillery

15r buys 1 round

Heavy Artillery

20r buys 1 round

Super-Heavy Artillery

25r buys 1 round

Gas Canister: Contains Incredible intensity tear gas. Those failing an Endurance FEAT roll are able to move but take no other action while in the cloud. Covers 1 area.

Knock-out Canister: Remarkable intensity knock-out gas in a single area. Those failing an Endurance FEAT roll are knocked out for 1-10 rounds.

Smoke Canister: Clouds a single area with Excellent intensity smoke.

Explosive Canister: Doubles standard damage to all in that area.

Incendiary Canister: Inflicts stated damage in fire, which burns for 1-10 rounds until snuffed out.

### GYRO-JET AMMO

Gyro-jet ammo is a self-propelled charge which only fits the gyro-jet handgun.

Standard Gyro-jet inflicts stated damage

1r buys 5 rounds

Explosive Gyro-jet inflicts double damage

1r buys 1 round 25

Heat-Seeker tracks on hottest target in the target area (multiple targets of same heat are chosen randomly)

1r buys 1 round

(Explosive Heatseeker would cost 5r for 1 round)

### NEEDLE AMMUNITION

Needle ammunition is used for needle guns similar to the one presented.

10r buys 1 clip

### GASES

Gases are sold in amounts to flood a typical area for a single round.

Smoke and Tear Gas: as Grenade of that type.

Knock-out Gas, based on intensity:

### FEEBLE

Cost: 20r

### POOR

Cost: 40r

### TYPICAL

Cost: 60r

### GOOD

Cost: 100r

### EXCELLENT

Cost: 200r

### REMARKABLE

Cost: 300r

### INCREDIBLE

Cost: 400r

### AMAZING

Cost: 500r

### MONSTROUS

Cost: 750r

### UNEARTHLY

Cost: 1,000r

There are a number of ways to deliver gas into a certain area, each with their own cost and a limit of the maximum of the intensity gas to be contained within.

### GAS PELLETS

- May be dropped in same area as user.
- Contains up to Good intensity gas.
- Cost Two times listed potency.

### GAS GRENADES

- May be thrown as standard grenades.
- Contains up to Remarkable Intensity gas.
- Cost Three times listed potency.
- Gas grenades are those available on the market. The higher cost reflects customized expense.

### GAS BOMBS

- See Missile Payloads.
- Alternate uses by doubling potency price.

### GAS AEROSOL

- Used with range of individual in contact.
- Contains up to Excellent intensity gas.
- Cost is two times listed potency.

## MISSILES

Missiles are used by missile launchers, are controlled in their movements and carry a payload. Payment for payload and control method is separate from missile and launcher.

### Standard Missile

Body	Control	Speed
Ex	Rm	Ex

**Cost:** NA/50r

### High-Tech Missile

Body	Control	Speed
Ex	In	Ex

**Cost:** NA/100r

### High-Speed Missile

Body	Control	Speed
Ex	In	Am

**Cost:** NA/150r

## CONTROL DEVICES

Missiles without control devices fly only in a straight line, hitting their target on the Shift 0 column.

### REMOTE CONTROL: WIRE-GUIDED

**Cost:** NA/25r

Information to control the missile is relayed through light weight wires (Feeble material) that trail from the missiles rear. Maximum range of such missiles is 10 areas. Damaging those wires causes the missile to go out of control.

### REMOTE CONTROL: TELE-GUIDED

**Cost:** NA/75r

A camera is set in the nose of the missile and an operator up to five miles away can control the missile. Use the Control of missile or Agility of controller (whichever is lower), to determine Agility FEAT for this type of missile.

### REMOTE CONTROL: COMPUTER-GUIDED

**Cost:** NA/100r

An internal programming unit within the missile is programmed against a specific target. If multiple similar targets are available the missile is able to determine its true target on a yellow FEAT on the Poor column.

### REMOTE CONTROL: RADIO TRACER

**Cost:** NA/50r

The missile homes in on a specific, preset radio wavelength, either from a sending unit or from a tracer planted on the target. Destruction of the tracer or ceasing of the signal causes the missile to hit the last known position of the tracer.

### REMOTE CONTROL: HEAT SEEKER

**Cost:** NA/50r

This form of guidance locks in on the highest heat source ahead of it (usually a jet engine or flaming hero). The missile turns with the heat source, but may be sidetracked by a more powerful source of heat.

## MISSILE PAYLOADS

### Standard Explosive

40 points to all in target area

**Cost:** NA/40r

### Concentrated Explosive

40 points to target only

**Cost:** NA/25r

### High Explosive

70 points to all in target areas

20 to all in adjacent areas

**Cost:** NA/60r

### Fragmentary Explosive

40 points H&S to all in area

**Cost:** NA/40r

### Incendiary

40 points fire damage

**Cost:** NA/50r

### Gas

Amazing intensity gas for target area

**Cost:** NA/500r

### Atomics

1,000 points damage, 5 area radius

100 points, 10 areas beyond that

75 points, 30 areas beyond that

Monstrous radiation damage to any within that area for the next year.

**Cost:** Not available in ordinary situations.

**Note:** Missile payloads may be dropped without the missile components from aircraft. They fall straight down and are known as bombs.

## GRENADES

All grenades may be thrown by hand, or fired using a grenade launcher.

### High Explosive

30 points of damage to all in target area.

**Cost:** 20r/30r

### Smoke Grenades

Fills target area with thick smoke.

Two column shift left for FEATs in this area.

**Cost:** 10r

### Tear Gas Grenades

Fills target area with tear gas.

Two-column shift left for FEATs.

All in area make Endurance FEAT or become nauseous, unable to act that round.

**Cost:** 20r/30r

### Knock-out Gas Grenade

Fills target area with knock-out gas of variable intensity gas.

**Cost:** Good intensity 100r/100r

Excellent intensity NA/200r

Remarkable Intensity NA/300r

### Flash Grenade

Amazing intensity flash that blind for 1 to 10 rounds.

**Cost:** 10r/20r

### Concussion Grenade

Inflicts Incredible Slugfest damage

**Cost:** 40r/50r

### Sonic Grenade

Inflicts Excellent sonic damage to all in target area.

**Cost:** 50r/60r

## EXPLOSIVES

Ordinary explosives are rated according to damage. The first rank is for damage in an area, the second is damage in adjacent areas

### FEEBLE

**Cost:** 20r

### POOR

**Cost:** 40r

### TYPICAL

**Cost:** 60r

### GOOD

**Cost:** 100r

### EXCELLENT/TYPICAL

**Cost:** 200r

### REMARKABLE/GOOD

**Cost:** 300r

### INCREDIBLE/EXCELLENT

**Cost:** 400r

### AMAZING/REMARKABLE

**Cost:** 600r

### MONSTROUS/INCREDIBLE

**Cost:** 750r

### UNEARTHLY/AMAZING

**Cost:** 1,000r

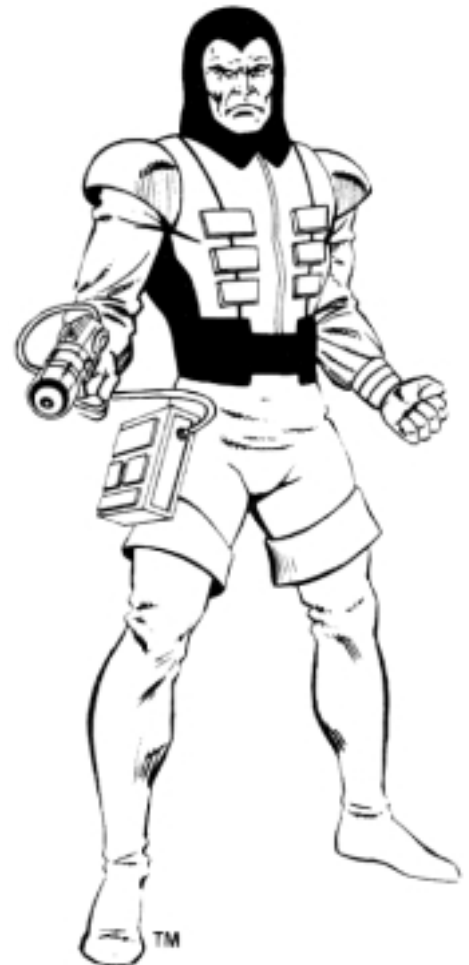

## BOWS

### LONG BOW

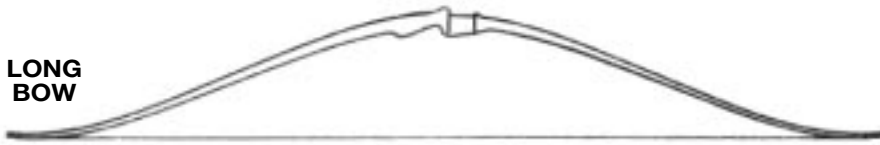

### REGULAR BOW

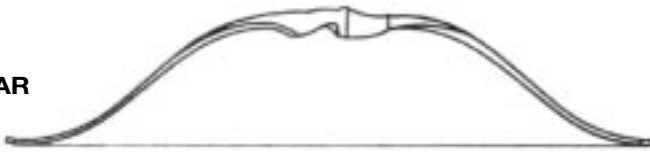

### COMPOUND BOW

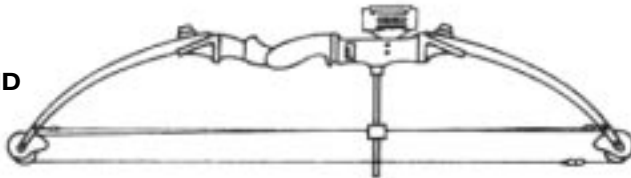

#### BOW, REGULAR

**Price:** 4r/8r

**Range:** 5 areas

**Normal Damage:** 6 points

**Rate of Fire:** 1/round

**Design Notes:**

- Requires two hands to fire.
- Poor strength material.

#### BOW, LONG

**Price:** 6r/10r

**Range:** 6 areas

**Normal Damage:** 10 points

**Rate of Fire:** 1/round

**Design Notes:**

- Requires Typical Strength to use normally. Otherwise, a Strength FEAT roll is needed.
- Typical strength material.

#### BOW (HAWKEYE)

**Price:** 20r/30r

**Range:** 7 areas

**Normal Damage:** 15 points

**Rate of Fire:** 1/round (Hawkeye may fire up to 3/round)

**Design Notes:**

- Two-meter double recurved, compound longbow.
- Reinforced fiberglass, Good strength material.
- Requires Good strength to use properly. Those of less than Good strength must make a Strength FEAT roll to use.
- Requires two hands to fire.

#### CROSSBOW

**Price:** 15r/30r

**Normal Damage:** 10 points

**Rate of Fire:** 1 every 2 rounds

**Design Notes:**

- Requires two hands to fire. Shift left two if fired with one hand.
- Typical strength material.

## ARROWS

Standard arrows or quarrels inflict damage according to the type of bow used:

**Regular**

6 points damage

**Cost:** 1r for 12

**Long**

10 points damage

**Cost:** 1r for 12

**Compound**

15 points damage

**Cost:** 1r for 6

#### ARROWS (HAWKEYE™)

Hawkeye maintains a quiver of 36 shafts, each shaft held in place by a clamp to prevent the arrows from spilling out. Of these arrows, Hawkeye maintains the following balance:

- 12 Standard blunt-tip arrows (Excellent Slugfest damage) for compound bow
- 6 Broad-blade arrows (Excellent S&T damage)
- 18 Assorted specialty headed arrows.

#### DESIGN NOTES

Hawkeye's uniform also contains 24 modules for holding spare arrow tips. These may be fitted to a standard arrow in a single round.

#### Specialty Heads

- Explosive Arrowhead: Amazing damage to single target or area.
- Smoke Arrowhead: Covers one area as Smoke Grenade.
- Tear Gas Arrowhead: Covers one area as Tear Gas Grenade.
- Flare Arrowhead: Good intensity light for 2 area radius, plus Good fire damage to targeting effect or Amazing damage to flaming target.
- Cable Arrowhead: Reduces range to 2 areas, trails cable of Incredible strength material.
- Electrical Arrowhead Inflicts Amazing electrical damage to target maximum range 5 areas.

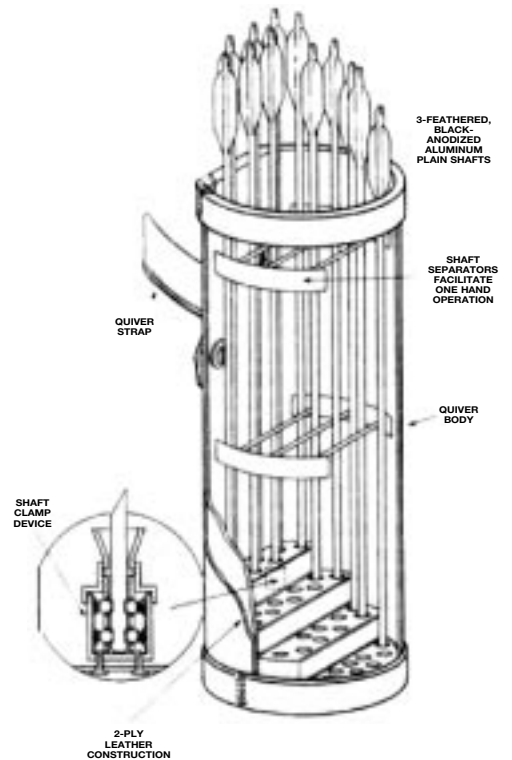

- Acid Arrowhead: Delivers Monstrous intensity acid to target. Range 3 areas.
- Thermal Arrow: Inflicts Remarkable heat damage to target.
- Suction Cup Arrowhead: Holds onto smooth surface with Remarkable strength.
- Vibration Arrowhead: Inflicts Excellent vibration damage on the Slugfest chart.
- Magnetic Arrowhead: Holds onto metallic surfaces with Incredible strength. May trail cable.
- Putty Arrowhead: Adheres to rough surfaces with Excellent strength. May also gum up exposed machinery with Remarkable ability.
- Siren Arrowhead: Generates Excellent intensity noise in every area the arrow passes through. Those within those areas must make an Endurance FEAT roll or be stunned for a total of 1-10 rounds.
- Rocket Arrowhead: Self-contained rocket increases range by 1 area. May be used in conjunction with other arrowheads.
- Boomerang Arrowhead: Returns to owner by means of computer homing device. Maximum range of 5 areas May be coupled with other arrowheads.





## MELEE WEAPONS

Thrown items are dependent on strength of the thrower for range, but Agility to hit a target.

Strength Rank		Range
FEEBLE	Strength throws	1 Area
POOR	Strength throws	1 Area
TYPICAL	Strength throws	1 Area
GOOD	Strength throws	2 Areas
EXCELLENT	Strength throws	3 Areas
REMARKABLE	Strength throws	4 Areas
INCREDIBLE	Strength throws	5 Areas
AMAZING	Strength throws	6 Areas
MONSTROUS	Strength throws	7 Areas
UNEARTHLY	Strength throws	8 Areas

Thrown items attacks are resolved on the Shooting and Throwing column of the Universal Table, with the "Kill" result becoming "Stun" in the case of blunt items.

### KNIFE

- In game terms, a knife is any blade up to 12 inches long.
- Damage 10 points, H&S or S&T.
- Excellent strength material.

- Can be wielded with one hand.
- **Cost:** 1r

### SWORD

- Any of a number of weapons with a blade longer than 12 inches, including cutlasses, rapiers, sabers, sais, and scimitars.
- Excellent strength material.
- Can be wielded with one hand.
- Damage 10 points, H&S or S&T
- If used with the flat of the blade, damage is Slugfest Damage is strength raised by one rank to a maximum of Remarkable.
- **Cost:** 3r

### GREAT SWORD

- Sword designed to be wielded with two hands.
- Damage 15 points, H&S.
- May not be thrown.
- Excellent strength material.
- May be used with flat of the blade as a normal sword.
- **Cost:** 10r

### AXE

- Chopping blade with handle 1 to 3 feet long.

- Wielded with one hand for 5 points, H&S.
- Wielded with two hands, 15 points, H&S.
- Good strength material.
- Thrown for 10 points, S&T.
- Used with flat of blade raises damage by one rank, to a maximum of Excellent, on the Slugfest column.
- **Cost:** 6r

### SPEAR

- Any thrusting blade with handle over 1 foot long.
- Wielded with two hands for 10 points H&S.
- Thrown for 10 points, H&S
- Good strength material.
- **Cost:** 1r

### CLUB

- Any one-handed blunt weapon of wood.
- Good strength material.
- Inflict one Strength rank higher in Slugfest with a maximum of Excellent.
- Thrown for 10 points, H&S, Kill is now Stun
- **Cost:** 1r

### SHURIKENS

- Small circular disks with sharpened edges or spike-like teeth, used in the Orient.
- Excellent strength material.
- Inflict Good damage, S&T.
- Thrown for maximum range of 3 areas
- **Cost:** 2r for 3

### BOOMERANGS

- Flattened, curled throwing weapon from Australia.
- Made of Good strength material, often better.
- Inflicts Good Slugfest damage.
- Thrown as normal weapon, of a skilled practitioner, does not return to the thrower.
- **Cost:** 1r/2r

### BRASS KNUCKLES

- Metal fittings over the hands, would include hitting someone with a mailrank, up to Remarkable maximum.
- Used on one hand.
- **Cost:** 1r

### WHIPS

- Long strands of rope, leather, or metal, allows user to hit non-adjacent targets in same area.
- Use S&T table to resolve hit Kill is now Hold.
- Any Hold is of material strength of material. Rope has Poor holding, leather Typical, and a metal whip may have Good and or better material strength.
- **Cost:** 1r for rope, 3r for leather, 10r for metal

### ELECTRO-KNUCKS

- Metal fittings over the hands which deliver an electric shock in addition to normal damage.
- Good strength material.
- Inflicts Remarkable damage.
- Used on one hand.
- **Cost:** 20r 28



## UNIQUE WEAPONS

### BATTLEVEST (FIXER™)

Designed, built, and used by Norbert Ebersol.

**Description:** Armored vest covering the wearer's upper torso containing many internal weapon systems.

### KNOWN POWERS

Fixer's battle-vest is made of Remarkable strength materials and contains a wide variety of weapon systems.

### JERICHO TUBE

- Shoulder-mounted voice-amplifying sonic blast.
- Inflicts up to Remarkable sonic damage.
- Used primarily against stationary, non-living targets.
- Range of 2 areas.

### EXPLOSIVE SPHERES

- Mounted in launchers in the shoulder and chest plate
- Range of 3 areas.
- Explode for Remarkable damage against a single target.
- Used primarily against living, non-armored targets.

### NEUTRINO SHELL

- Mounted in launchers in the shoulder and chest plate. Can be used with separate blaster.
- Range of 3 areas.
- If hits, stuns the target with Remarkable intensity electricity.
- Used primarily against living, non-armored targets.

### NEUTRALIZER SHELL

- Mounted in launchers in the shoulder and chest plate.
- Range of 3 areas
- If hits, will neutralize electric equipment with Amazing ability.
- Used primarily against targets in battle-suits.

### PLASTICIZER SHELL

- Mounted in launchers in the shoulder and chest plate.
- Range of 3 areas.
- If hits, coats the area hit with a quick-hardening Plastic of Remarkable Strength.
- Used against energy sources.

### RESTRAINING CLAMP

- Mounted in belt of battle vest
- Range of 2 areas.
- If hits, uses an induced gravity field to hold the target to the ground with Incredible strength
- Used to prevent mobile targets from escaping.

### ELECTRICAL SHOCK

- Part of outer surface of battlevest.
- Those touching the vest when activated take Incredible electrical damage.
- Used when grappled, has no effect on wearer of the vest.

### FLIGHT

- Jet-thrusters in backpack
- Flight at Incredible (7 areas/round) speed.

The Fixer's battlevest is a combination of a large number of weapon systems developed by the criminal over the years.

### WEB-SHOOTERS (SPIDER-MAN™)

Designed, built and worn by PETER PARKER™

### KNOWN POWERS

- Two high-pressure turbines used to jet a thin stream of "web fluid" over a great distance.
- Device is made of stainless steel with teflon internals. Made of Excellent materials.
- Range of Web-shooter is 3 areas.
- "Web fluid" is an artificial material stored under high pressure in a container in each wrist. Each cartridge has approximately 100 uses and additional cartridges are worn on the belt.
- "Web fluid" is Monstrous strength material which sets up in a single round, and is used for weblines, protective shields, and restraining devices for opponents.
- Use of other materials in the web-shooters results in damage to the mechanisms.

### WIDOW'S BITE (BLACK WIDOW™)

Designed and built by S.H.I.E.L.D.

Used by NATALIA ALLANOVNA ROMANOVA™

### KNOWN POWERS

- Small device located in wristband capable of firing a high frequency electrostatic charge.
- Range of 1 area.
- Inflicts Excellent electrical damage.

The Widow's Bite was developed for Natalia Romanova (also known as Natasha Romanoff, publicly known as the Black Widow) by S.H.I.E.L.D. special weapons branch following her defection to the United States and used to aid S.H.I.E.L.D. and the US security agencies.

### SPECIALIZED BOOMERANGS (BOOMERANG™)

Designed and built by Justin Hammer

Used by FRED MYERS™

### KNOWN POWERS

- All boomerangs have a maximum range of 4 areas. A skilled practitioner may cause their flight path to bend around corners, circle in a single area or return to the thrower's hands.
- All boomerangs are made of Excellent strength material unless otherwise noted.
- Shatterang: Explodes for Amazing damage in a single area.
- Gasarang: Pumps tear gas along the entire flight path of the boomerang.
- Gasarang II: Pumps knock-out gas of Remarkable potency in a single area.
- Razorang: Inflicts Remarkable H&S dam-

age. Made of Incredible strength material.

- Bladerang: A finely-honed version of Razorang inflicts Incredible H&S damage. Has no effect on Good or better strength materials.
- Screamarang: Inflicts Excellent intensity sonic damage in a single round each round they are in the air.
- Gravityrang: Attaches upon hitting, creating a localized gravity field of Incredible strength.
- Reflexrang: Solid weighted boomerangs. On a "Bullseye," has hit a pressure point. Target must make an Agility FEAT roll or fall, then an Endurance FEAT roll or be knocked out for a total of 1-10 rounds.

### DESIGN NOTES

As Boomerang, Myers was well-trained in the use of his weapons, throwing them with Incredible Agility. Despite their well-balanced design (refined by Justin Hammer for a modest portion of the profits), a newcomer to the field would be no more able to improve his abilities than one rank above his Agility. Boomerang wears up to seven of these boomerangs on his outfit.

### BILLY CLUB (DAREDEVIL™)

Designed, built, and used by Matt Murdock

### KNOWN POWERS

- Billy club constructed of high-strength aircraft aluminum, an Amazing strength material.
- May be wielded in combat, raises damage by one rank, maximum of Monstrous.
- Lower half of club fires a swing line into any adjacent area Using this swing line, the user may swing up to 3 areas a turn.
- The billy club may be modified to resemble a blind man's cane.

The hero, Daredevil makes use of the billy club as a form of transportation and his sole weapon. It has remained similar in design since its creation, with very few modifications.

### GAS GUN (BELLADONNA™)

Designed and used by Narda Ravanna

**Description:** Appears as a standard handgun

### KNOWN POWERS

- Fires pellets of a knock-out gas based on the Belladonna plant.
- Knock-out gas is Amazing potency.
- Range of 3 areas
- Gas has side effect of acting as Incredible strength acid with adhesives, including Spider-Man's webbing.

### DESIGN NOTES

Narda Ravanna was the creative head of a European cosmetics firm put out of business by its competitors. Ravanna developed both gas and the modified handgun and, as Belladonna, set out for revenge She is currently under arrest though the fate of her creations is not known.

### NEUTRALIZER (FORGE™)

Designed and built by Forge  
Used by PETER HENRY GYRICH™

#### KNOWN POWERS

- Hand-held ray-gun firing a beam that removes inherent super-powers from the target.
- Range 5 areas.
- Neutralizer Ray is of Amazing intensity. Those struck by the ray must make a Psyche FEAT roll or lose all inherent super-powers. Those beings with technological powers or whose racial type has special powers (such as SKRULLS™) would be unaffected. Affected targets would have maximum ability scores of Excellent and all special powers (but not talents) stripped.
- The gun has a number of settings, determining the length of time the effects work. At its lowest setting, it robs mutant powers for 1-10 rounds. At its highest, it permanently strips these powers.

#### DESIGN NOTES

The master inventor known as Forge is himself a mutant, with his mutation allowing him his powers of invention. Working freelance for the Department of Defense, Forge created the Neutralizer to be used against dangerous mutants, but in its first field test, Peter Henry Gyrich used it to strip STORM™ of her powers. The weapon was later destroyed by Iron Man. It is highly unlikely that Forge will create or use more neutralizers.

### SPECIALIZED WHIP (BLACKLASH™)

Designed and built by Justin Hammer  
Used by MARK SCARLOTTI™

#### KNOWN POWERS

- Two cybernetically-controlled whips, made of woven boron-filament impregnated saphire strands in a steel braid.
- Each whip is stored in a sheath in Blacklash's gloves.
- Whips may be wielded for Remarkable Slugfest damage up to 1 area away.
- Whips may be spun to provide Excellent protection from physical and energy attacks to the user and those behind the spinning screen.
- Each whip may be shortened to become a nunchaku. Each nunchaku inflicts up to Excellent damage. Scarlotti may wield both whip and nunchaku at once.
- If elongated and stiffened, the whip may become a vaulting pole. Allows user to clear a one-story building.
- If whip is grabbed or securely wrapped around a target, the whip may be detached from its handle. The next round, the detached whip explodes for Incredible damage to those touching the whip, and Excellent damage to all those in same area.

#### DESIGN NOTES

Mark Scarlotti began his costumed criminal career as WHIPLASH™, but after several defeats, changed his costume and name to Blacklash, with his trademark whips redesigned by scientists working for Justin Hammer. After several more failed jobs, Scarlotti was abandoned by the MAGGIA, his main

employer, and is now working freelance.

### MODIFIED HANDGUN (ENFORCER™)

Designed and built by The Committee  
Used by CARSON COLLIER, JR™

- Two target pistols modified to take special ammunition. All abilities and material strength as for handgun.
- Tranquillizer Pellets of Incredible potency.
- Pyrogranulate capsules which ignite upon impact for Remarkable fire damage.
- Silver bullets.
- "Tingler" capsules Remarkable potency chemical that cause a metabolic change in the victim, causing the victim to burst into Remarkable strength flames upon command.

#### DESIGN NOTES

Carson Collier, Jr, son of the 1940s cowboy star "Coot" Collier, dropped out of school to take up a life of crime. His efforts were aided by The Committee, a group of corrupt businessmen, who provided the funding for his weapon. With the demise of The Committee, Enforcer went freelance. He was slain by a mysterious figure while working for Obadiah Stane. His gun may have survived him.

### MODIFIED HANDGUN (RED SKULL™)

Designed, built and used by the Red Skull

#### KNOWN POWERS

- Fires pellets of Dust of Death.
- Range of 3 areas.
- Dust of Death is an Incredible intensity poison with special attributes. Should the target fail an Endurance FEAT against the dust, the victim loses hair and skin tightens and discolors to resemble a red skull.

This infamous device has become a trademark of the Red Skull in his long and infamous career. He has not used it against others of equal talent (such as Captain America), but rather reserved it for use against failing menials and opposing agents. With the death of the Red Skull, the fate of his invention is unknown.

### HATE-RAY (HATE-MONGER™)

Designed and built by Unknown  
Used by Adolf Hitler

#### KNOWN POWERS

- Hand-gun sized and shaped ray gun that beams a high frequency microwave radiation at the target. This radiation stimulates those portions of the brain that feel dread, fear, and anger, magnifying them.
- The intensity of this ray is Incredible. Those failing a Psyche FEAT roll are consumed by rage, with feelings of love and respect turned to equally deep feelings of rage.
- Range of 5 areas.
- May be trained on a single target or the beam widened to affect all targets in a single area.

#### DESIGN NOTES

The Hate-ray, or H-ray, was developed by the original Hate-Monger to encourage world



unrest. The original Hate-Monger appears to have been a clone of dictator Adolf Hitler, imbued with the original's memories and Psyche. This Hate-Monger has been imprisoned in a facsimile of the Cosmic Cube. Since that time, there have been two other Hate-Mongers using similar emotion-affecting rays. The first proved to be the MAN-BEAST™, the second an agent of the PSYCHO-MAN™.

### MELTER RAY (MELTER™)

Designed and built by BRUNO HORGAN™ with Tony Stark  
Used by Bruno Horgan

### KNOWN POWERS

- The melter ray uses microwave frequencies to loosen the molecular binding of a specific type of material. Only one of the four settings may be used at any time.
- Range of 2 areas.
- Setting One: Metal—Affects material up to Monstrous material, causing them to “melt”. Inflict damage as an Attack of Monstrous strength.
- Setting Two: Stone—Affects rock and stone of non-mystical origin or stone unaffected by magic at the Uearthly level. Inflicts damage on non-magical stone beings with Uearthly strength.
- Setting Three: Wood—Attacks the cellulose in plant life. Inflicts Amazing damage on plants and Amazing damage to wooden objects and plant-based cloth.
- Setting Four: Flesh—Does not melt but rather burns animal tissue for Amazing damage. Each round makes an Endurance FEAT roll or become unconscious from the disruption.

### DESIGN NOTES

The Melter ray was accidentally created by Bruno Horgan, a U.S. defense contractor who used shoddy materials and eventually lost his business to Stark International. The original Melter ray, based on a faulty radar dish, only affected metal, but Horgan kidnapped Tony Stark and forced him to improve the set to its present power. As the Melter, Horgan was defeated on numerous occasions by Iron Man. Horgan was finally slain by a mysterious assailant. The fate of the Meller ray is currently unknown.

### CONCRETE GUN (RADIOACTIVE MAN™)

Built and designed by: Unknown  
Used by DR CHEN LU™ (RADIOACTIVE MAN)

### KNOWN POWERS

- Shoots a steady stream of quick-hardening concrete mixture.
- Concrete hardens in a single round to Incredible strength.
- Range of 2 areas

### DESIGN NOTES

This gun is of unknown origin, but likely created by some weaponsmith of the criminal element. Radioactive Man used this weapon in combat with the Avengers, but has since abandoned it.

### MODIFIED HANDGUN (MISTER FEAR™)

Designed and built by ZOLTAN DRAGO™  
Used by ALAN FAGAN™

### KNOWN POWERS

- The fear gun is a specially modified handgun that fires “fear pellets” up to 5 areas away.
- Fires pellets made of a chemical compound that triggers the reactions of fear and flight in humans and animals. Those affected must make an Endurance FEAT roll against Uearthly intensity drug. Those failing to make that FEAT roll seek to place as much distance between themselves and the user as possible.
- A single pellet covers single area.

### DESIGN NOTES

The fear gun and its specialized pellets were first created by the first Mister Fear, Zoltan Drago, and used by three others who followed his methods in crime. The most recent Mister Fear, Alan Fagan, has been arrested, and his gun, costume, and about 100 gas pellets are now in the custody of police.

### PASTE-GUN (TRAPSTER™)

Designed, built, and used by PETER PETRUSKI™

### KNOWN POWERS

- The paste-gun is a device used to shoot Petruski's specially-developed paste under high pressure.
- Material strength of paste-gun and containment canister worn at belt is Remarkable. Material strength of the tubing connecting the two is Typical Strength.
- Sets up immediately as Monstrous strength material which is unaffected by fire and acids. The paste may be used underwater without difficulty. The paste-gun reacts poorly with sunlight and dissolves in five hours.
- Range of weapon is 2 areas.

### DESIGN NOTES

The paste-gun is the primary weapon of the Trapster, also known as PASTE-POT PETE™, a research chemist who used his talents in chemistry for criminal gain. Defeated by the HUMAN TORCH™, Pete teamed up with the WIZARD™ as a member of the FRIGHTFUL FOUR™, and remained with that group until its disbanding. He fought the FF on several occasions, always meeting with defeat most recently being defeated by the defensive systems of the BAXTER BUILDING™.

### SHOOTING IRONS (SHOOTING STAR™)

Designed and built by REMINGTON STARWIN™  
Used by VICTORIA STAR

### KNOWN POWERS

- Two six-shot handguns redesigned to take special ammunition.
- Special ammunition is in the form of star-shaped pellets that have Remarkable Intensity paralysis abilities.
- Range of 4 areas
- Rate of fire 1/round

### DESIGN NOTES

Victoria Star, rodeo performer, credits her hardware to her father, Remington Starwin, and uses it in adventuring.

### NULLATRON (RINGMASTER™)

Original design by unknown scientists  
Modified and used by Maynard Tiboldt

### KNOWN POWERS

- Ringmaster's hat contains a powerful, scaled-down version of the nullatron, a mind-control device.
- The nullatron increases psionic power to the point of allowing the wearer to hypnotize large groups of people.
- The hat raises the wearer's Psyche by three ranks, to a maximum of Amazing. This is the intensity of the mind control of the wearer.
- Those who are confronted by the power of the hat must make a Psyche FEAT roll or fall under the hypnotic control of the hat's wearer.
- Range is 3 areas.
- An unlimited number of targets within the area may be affected.
- The hat allows the wearer to mentally project hypnotic commands without speaking.
- The hat is equipped with projector that transmits bright lights and patterns to further reduce the opponent's mental resistance. Those viewing the hat have their Psyches reduced by one rank for purposes of FEAT rolls.

### DESIGN NOTES

The Ringmaster's hat is a modification of the Nullatron, a device created by scientist in Nazi-occupied Europe who were slain by the Red Skull after inventing the device. The original Nullatron was used to subvert the wills of Allied agents, including the INVADERS™, but was destroyed by that latter group. Tiboldt's Father, Fritz, came into possession of the device, and Maynard Tiboldt inherited it from him. After attempting to make it in America with his small circus, Maynard Tiboldt, as Ringmaster, modified the Nullatron to fit in his hat, and used it to hypnotize and rob large group of people as the circus moved across country.

### BATTLE-STAVES (MOCKINGBIRD™)

Designed and built by S.H.I.E.L.D.  
Used by BARBARA MORSE BARTON™

### KNOWN POWERS

- Two hollow steel-alloy poles made of Remarkable strength material, worn in slings beneath each arm.
- Thrown as a javelin, range of 4 areas, for Remarkable slugfest damage.
- Used as a bo stick in Slugfest combat. Inflicts Remarkable Slugfest damage.
- Spring-loaded holders may fire the batons up to 3 areas for Remarkable Slugfest damage.
- Battlestaves may be extended to a full 8 feet, creating a vaulting pole allowing the user to clear one-story buildings.

Mockingbird's battlestaves are a good exam-

ple of multi-purpose weapons of this type that may have a variety of uses.

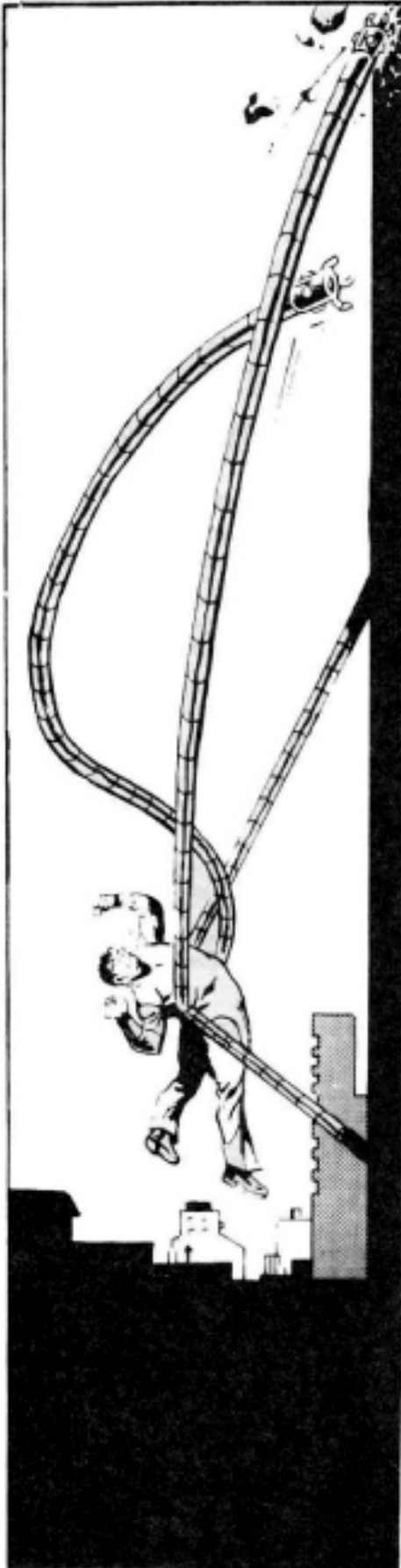

### SHIELD (CAPTAIN AMERICA™)

Designed and built by DR. MYRON MACLAIN™

Used by STEVE ROGERS™

#### KNOWN POWERS

- A 2.5' diameter concave disc made of a unique mixture of adamantium and vibranium, coated with a high enamel mixed with titanium nitride.
- Made of Class 1000 material, to all forms of energy and physical damage except magic and psionic powers.
- The shield may absorb up to 90 points of damage in a single round. User may not attack in that round, and is still subject to effects of stunning and slamming.
- May be thrown (range dependent on user's strength) for up to Remarkable damage. Captain America is extremely talented using the shield, such that he may bounce it off targets and have it return to his hand. This is an ability of the thrower not of the shield, though it is very light and rebounds off solid targets.

#### DESIGN NOTES

Captain America's shield was made by Dr. Myron MacLain, who was later to discover true adamantium. In one of his experiments using an early adamantium alloy and a sample of Wakandan vibranium, MacLain discovered a perfect mixture, which he poured into a disc-shaped test mold. Dr. MacLain had fallen asleep during part of his own experiment, and during that time something else may have entered the mixture, for the result was unreproducible. The resulting disc was as tough and powerful as true adamantium would later prove to be, with the ability to withstand large amounts of damage. The disc, being government property, was presented to Captain America early in his career by FDR, replacing the badge-shaped shield he had until then (this first Shield was stored in an Army warehouse in Steve Rogers's footlocker and was later destroyed in an attack by a bogus Baron Strucker). Captain America has had literally decades of practice with his shield, making the team of invulnerable shield and unbeatable spirit-tough opponent for any foe.

### METAL ARMS (DOCTOR OCTOPUS™)

Designed and worn by OTTO OCTAVIUS™

#### KNOWN POWERS

- Four prehensile, electrically-powered titanium-niobium tentacles attached to a stainless steel waist harness.
- Tentacles are Amazing strength material.
- Pincers made of Remarkable strength material.
- Any single tentacle has Remarkable strength and may attack for Remarkable damage.
- Two tentacles working together, braced by the other two, may wield Incredible damage.
- Range of tentacles 1 area.
- May attack twice/round. Multiple attacks shift one to the right for every additional arm.
- The arms may move up to 4 areas/round, ignoring structures under two stories

high. May climb sheer surfaces at 3 stories/round.

- May be worn and mentally commanded (even at great distances) by Doctor Octo-



pus, even if arms have been severed from the harness.

#### DESIGN NOTES

The arms of Doctor Octopus were originally a chest-harness used to manipulate radioactive materials at a safe distance. A freak accident gave Doctor Octopus the power to control his arms as a living entity, even to the point of being able to give subconscious commands over a great distance.

### ADAMANTIUM ARMS (DOCTOR OCTOPUS™)

Designed and built by Doctor Octopus

#### KNOWN POWERS

- Harness similar in design to the standard harness for Doctor Octopus.
- Made of Uearthly material. Pincers made of Uearthly material.
- A single tentacle may inflict up to Monstrous damage. Two tentacles working together and braced may inflict Uearthly damage.
- Tentacles have a range of 1 area.
- May attack twice per round, with multiple attacks on the same target raising damage by one shift Maximum of Shift X (150 pts).
- May move up to 4 areas per round, ignoring buildings of two stories or less. May scale sheer surfaces at six stories per

round.

- Is under the command of the wearer. If no one is wearing the harness, Octavius may command the suit similar to his normal harness.

#### **DESIGN NOTES**

Doctor Octopus designed this harness as a duplicate of his original, though made of adamantium alloy, but abandoned it soon after its forging, returning to his original harness. The arms were kept in Ryker's Island under an energy field, but were "sprung" by Doctor Octopus and used to battle Iron Man. Iron Man defeated the adamantium arms, and used them to defeat the mad doctor. The present fate of this set of arms is unknown.

#### **POWER HORN (UNICORN™)**

Designed and built by Anton Vanko and others

Worn by MILOS MASARYK™

#### **KNOWN POWERS**

- Cybernetically-controlled headgear capable of firing a range of energy bolts from the crown of the helmet.
- May fire laser beams, including infrared and ultraviolet lasers for up to Monstrous S&T damage.
- May fire neutron- and electron-beams for up to Monstrous Slugfest damage.
- Range of all beams is 20 areas.
- Power supply located in wearer's belt.

#### **DESIGN NOTES**

Anton Vanko, designer of the Crimson Dynamo armor also designed a power helmet that used various radiation bands. He gave this helmet to Soviet intelligence agent Milos Masaryk and trained him in its use. Masaryk, as Unicorn, later came to America to retrieve the defector Vanko, only to be defeated by Iron Man. Following this defeat Masaryk engaged in subversive activities, then returned to his native Czechoslovakia. There the power horn was modified and increased in power. Unicorn returned to subversive activity, seeking a cure to cellular deterioration, the result of a treatment aside from the power horn. Unicorn has worked as an agent for RED GHOST™, MANDARIN™, and Titanium Man, and was last seen walking out to sea, trying to rendezvous with the latter. The fate of the power horn is unknown.



# DOCTOR OCTOPUS'S™ ARMS



DESIGNED AND CONSTRUCTED BY OTTO OCTAVIUS

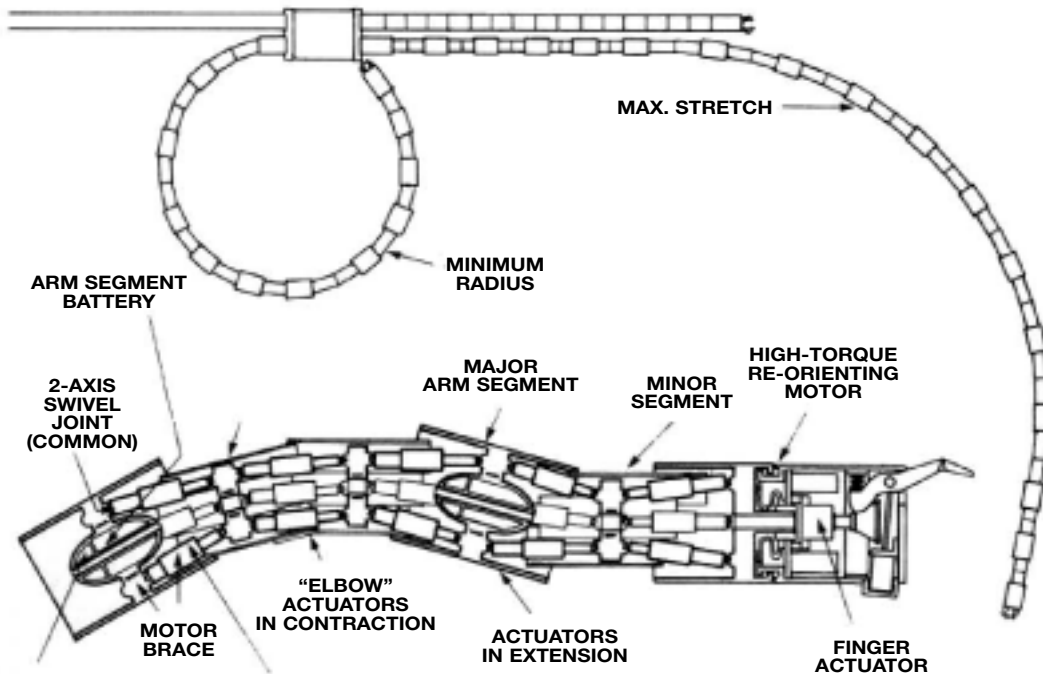
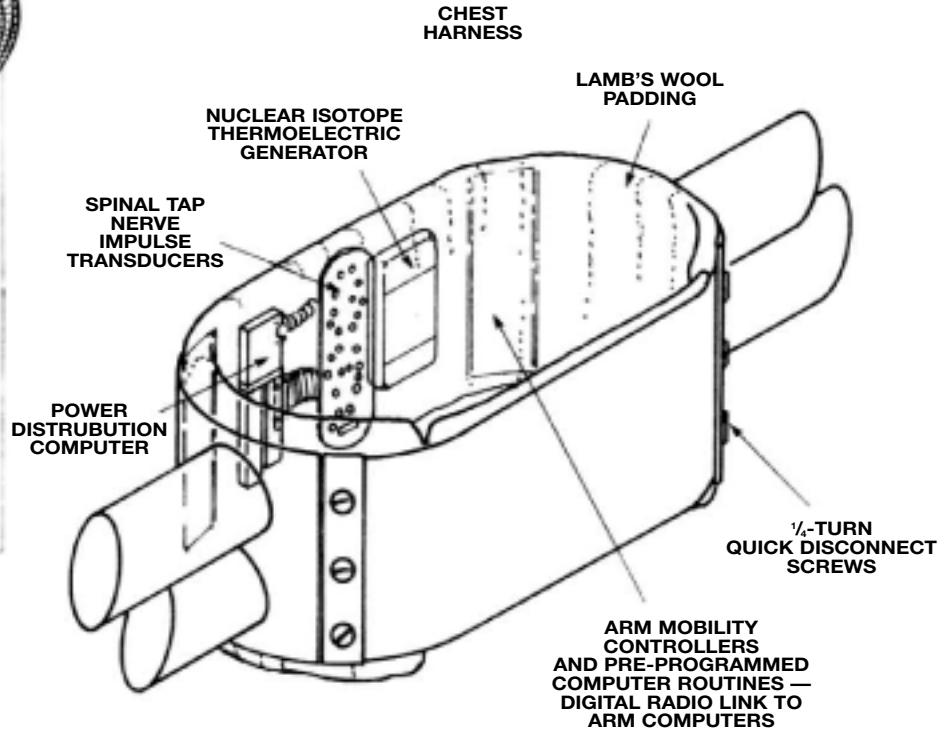

ELECTRONICS PACKAGE

MOTOR ARMATURE DRIVES 2 CYLINDERS IN OPPOSITE DIRECTIONS (TYPICAL)

CLOSE UP OF PINCER

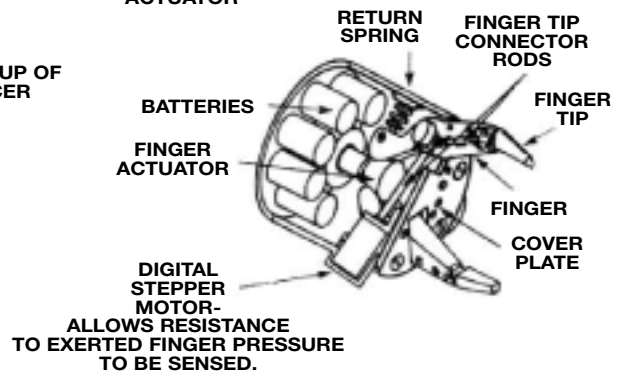

# MARVEL SUPER HEROES™

OFFICIAL GAME ACCESSORY

## WEAPONS LOCKER

By Jerry Epperson and Jeff Grubb

In a world that is filled with super-powered heroes, super-dangerous mutants, and super-deadly villains, what's an everyday criminal or multi-millionaire to do?

Get a Weapon. And fast.

Available weapons include:

Battlesuits, from S.H.I.E.L.D.™ body armor to the latest fashions for IRON MAN™; the powered weapon suits of the United States and Soviet Governments; weapons, from cheap handguns to atomic-tipped missiles; special weapons, including the mighty shield of CAPTAIN AMERICA™ and the awesome arsenal of arrows of HAWKEYE™ the archer.

This accessory described the various vicious devices used by villains and heroes, so you can send in the MANDROIDS™ at a drop of a helmet.

Because you never know what the well-dressed villain is wearing this year...

WEAPONS LOCKER is a game accessory for use with MARVEL SUPER HEROES™ role-playing game, and contains a 32-page sourcebook of battlesuits and individual weapons used in the MARVEL UNIVERSE.



TSR Inc.  
POB 756  
Lake Geneva,  
WI 53147

6868XXX1401  
0-88038-229-5  
ISBN 394-54874-4TSR0600

PDF Edition 2.0  
Scanning and initial layout  
by Andrew McFayden  
Additional production  
on 12/1/01 by zan